

art VA00260

Descrizione/Features

Frustino in nylon con passamano.
Nylon whip with wrist loop.

Misure/Sizes

65 cm

Colori/Colors

- black I 001
- navy blu I 004
- red I 003
- yellow I 007
- royal blue I 008
- brown I 010
- pink I 011
- baby blue I 012
- green I 005



art VA00267

Descrizione/Features

Frustino lucido con manico grip.
Nylon whip with non-slip handle.

Misure/Sizes

65 cm

Colori/Colors

- black I 001
- navy blu I 004
- red I 003
- green I 005
- royal blue I 008



art VA00247

Descrizione/Features

Frustino in nylon con manico testa di cavallo.
Nylon whip with horse head handle.

Misure/Sizes

65 cm

Colori/Colors

- black I 001
- navy blu I 004
- red I 003
- green I 005
- royal blue I 008



art VA00260B

Descrizione/Features

Frustino in nylon tinta unita. Venduto in set da 10 pezzi.
Set of 10 pieces nylon whips.

Colori/Colors

come catalogo/as catalogue

Misure/Sizes

65 cm



art VA00260A

Descrizione/Features

Frustino in nylon bicolore. Venduto in set da 10 pezzi.
Set of 10 pieces nylon bicolor whips.

Colori/Colors
come catalogo/as catalogue

Misure/Sizes

65 cm



art VA01275

Descrizione/Features

Frustino con cavallini, filo argentato e manico zoccolo. Venduto in set da 10 pezzi.
Set of 10 pieces nylon whips whit horse hoof handle.

Colori/Colors
come catalogo/as catalogue

Misure/Sizes

65 cm



Umbria
EQUITAZIONE

art VA00221

Descrizione/Features

Frustino con manico in gomma modello scotland flying.
Nylon whip with rubber handle type scotland flying.

Misure/Sizes

65 cm

Colori/Colors

- black I 001
- violet I 014
- pink I 011



Umbria
EQUITAZIONE

art VA00222

Descrizione/Features

Frustino manico gomma modello shining flying.
Nylon whip with rubber handle type shining flying.

Colori/Colors

come catalogo/as catalogue

Misure/Sizes

65 cm



Umbria
equitazione srl
Official

207

www.umbriaequitazione.com

Umbria
EQUITAZIONE

art VA00268

Descrizione/Features

Frustino in nylon con manico punta metallo.
Nylon whip with metallic head button.

Misure/Sizes

65 cm

Colori/Colors

- black I 001
- red I 003
- green I 005
- royal blue I 008



Umbria
EQUITAZIONE

art VA00258A

Descrizione/Features

Frustino in nylon con manico grip e bottone argento.
Nylon whip with non-slip handle and button guard.

Misure/Sizes

60 cm

Colori/Colors

- black I 001
- red I 003
- green I 005
- royal blue I 008



Umbria
EQUITAZIONE

art VA01306

Descrizione/Features

Frustino bicolore fascia argento.
Bicolor whip with silver spiral plating.

Misure/Sizes

65 cm

Colori/Colors

- black I 001
- navy blu I 004
- red I 003
- yellow I 007
- royal blue I 008
- violet I 014
- pink I 011
- fuxia I 024
- green I 005
- lime I 023



Umbria
EQUITAZIONE

art VA01309

Descrizione/Features

Frustino manico grip con punta pelle vernice. Venduto in set da 10 pezzi.
Set of 10 pieces nylon whips with grip reflective handle and varnish flap.

Colori/Colors

come catalogo/as catalogue

Misure/Sizes

65 cm



Fruste e Frustini - Whips

art VA00269

Descrizione/Features

Frustino in nylon con manico grip.
Nylon whip with non-slip rubber handle.

Misure/Sizes

65 cm

Colori/Colors

- black I 001
- red I 003
- green I 005
- royal blue I 008



art VA00223

Descrizione/Features

Frustino con manico gomma modello silver stripe flying.
Nylon whip type silver stripe flying with non-slip rubber handle.

Misure/Sizes

65 cm

Colori/Colors

- pink I 011
- baby blue I 012
- black I 001
- lilla I 029



art VA00264

Descrizione/Features

Frustino manico a specchi con grip velluto e flap in pelle.
Nylon whip with velvet and glitter handle, leather flap.

Misure/Sizes

65 cm

Colori/Colors

- black I 001
- red I 003
- navy I 004
- royal blue I 008
- brown I 010



art VA00259

Descrizione/Features

Frustino manico golf con punta larga.
Golf handle whip with wide flap.

Misure/Sizes

65 cm

Colori/Colors

- black I 001
- red I 003
- green I 005
- royal blue I 008



art VA01307

Descrizione/Features

Frustino in nylon manico grip modello diamond velvet.
Nylon whip with velvet and diamond handle, leather flap.

Misure/Sizes

65 cm

Colori/Colors

- black I 001
- red I 003
- navy I 004
- red-black I 095

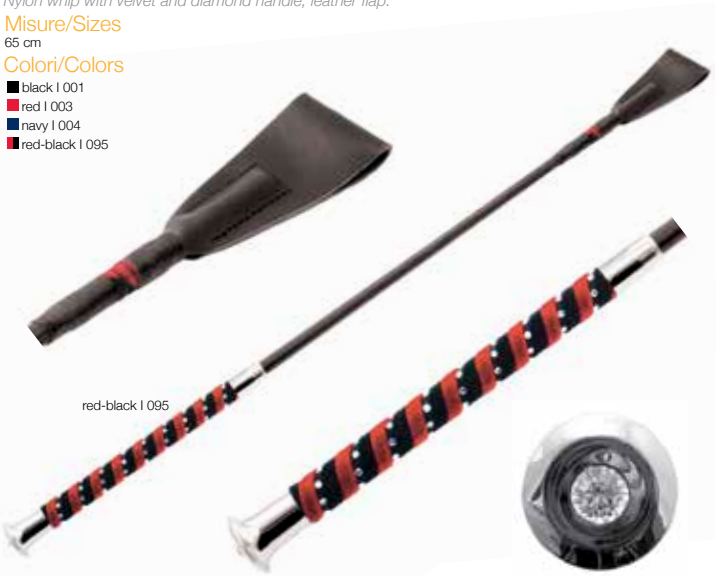

art VA01317

Descrizione/Features

Frustino tecno con manico in pelle e bottone in metallo.
Ultra-Light whip with leather handle and leather flap.

Misure/Sizes

65 cm

Colori/Colors

- black I 001



Umbria
EQUITAZIONE

art VA01302

Descrizione/Features

Frustino bicolore manico golf modello twisted flying.
Bicolor whip type twisted flying with rubber golf handle.

Misure/Sizes

65 cm

Colori/Colors

- black I 001
- white-black I 098
- navy-black I 094
- brown-black I 093
- yellow-black I 092
- red-black I 095



Umbria
EQUITAZIONE

art VA01305

Descrizione/Features

Frustino bicolore manico lungo modello master long flap.
Bicolor whip type master long flap with rubber golf handle.

Misure/Sizes

65 cm

Colori/Colors

- green-black I 090
- royal-black I 091
- yellow-black I 092
- red-black I 095



Umbria
equitazione srl
Official

209

Umbria
EQUITAZIONE

art VA00255

Descrizione/Features

Frustino in cuoio modello economy con bottone in metallo.
Leather whip type economy with metal button handle.

Misure/Sizes

65 cm

Colori/Colors

- black I 001
- brown I 010



Umbria
EQUITAZIONE

art VA00244

Descrizione/Features

Frustino in cuoio liscio.
Leather whip with leather handle.

Misure/Sizes

65 cm

Colori/Colors

- black I 001
- brown I 010



Umbria
EQUITAZIONE

art VA00245

Descrizione/Features

Frustino in cuoio liscio con manico punta metallo.
Leather whip with metallic head button.

Misure/Sizes

65 cm

Colori/Colors

- black I 001
- brown I 010



Umbria
EQUITAZIONE

art VA00288

Descrizione/Features

Frustino in nylon modello lungo.
Long nylon whip.

Misure/Sizes

90 cm

Colori/Colors

- black I 001



90
CM

Fruste e Frustini - Whips

art VA00248

Descrizione/Features

Frustino in nylon modello mano.
Nylon whip with leather hand flap.

Misure/Sizes
50 cm - 65 cm

Colori/Colors

- black I 001
- navy blu I 004
- red I 003
- yellow I 007
- royal blue I 008
- brown I 010
- pink I 011
- baby blue I 012
- green I 005



art VA00261

Descrizione/Features

Frustino in nylon modello short flying.
Nylon whip type short flying.

Misure/Sizes
50 cm

Colori/Colors

- black I 001
- navy blu I 004
- red I 003
- yellow I 007
- royal blue I 008
- brown I 010
- pink I 011
- baby blue I 012
- green I 005



Umbria
equitazione srl
Official

art VA00269C

Descrizione/Features

Frustino in nylon con manico grip.
Nylon whip with non-slip rubber handle.

Misure/Sizes
50 cm

Colori/Colors

- brown I 010
- green I 005
- royal blue I 008



art VA01301

Descrizione/Features

Frustino in nylon con punta stretta.
Nylon whip with tight flap.

Misure/Sizes
50 cm

Colori/Colors

- black I 001
- red I 003
- silver I 019
- royal blue I 008



art VA00172 - VA00172L

Descrizione/Features

Punta di ricambio per frusta e frustino.
Replacement whip popper.

Colori/Colors
come catalogo/as catalogue

Misure/Sizes
15 cm - 30 cm

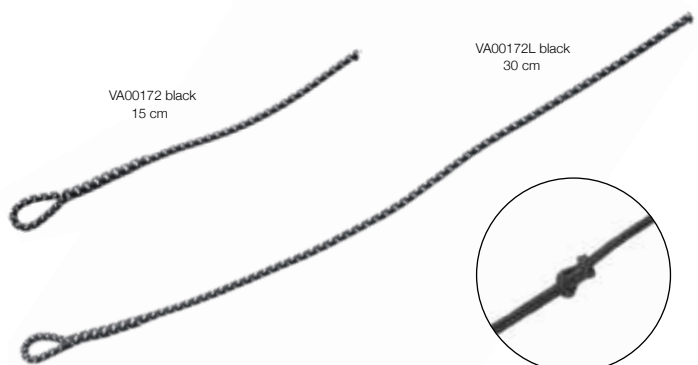

art VA01171

Descrizione/Features

Porta frustini da scuderia in legno con viti.
Wooden wall display for whips.

Colori/Colors
come catalogo/as catalogue



Umbria
EQUITAZIONE

art VA00280

Descrizione/Features

Frustino dressage in nylon modello economy.
Nylon dressage whip type economy.

Misure/Sizes

100 - 110 - 120 cm

Colori/Colors

■ black I 001



Umbria
EQUITAZIONE

art VA00274

Descrizione/Features

Frustino dressage in nylon con manico gomma master.
Nylon dressage whip with rubber master handle.

Misure/Sizes

100 - 110 - 120 - 130 cm

Colori/Colors

■ black I 001



Umbria
equitazione srl
Official

www.umbriaequitazione.com

211

Umbria
EQUITAZIONE

art VA01313

Descrizione/Features

Frustino dressage in nylon manico pelle modello air master.
Nylon dressage whip type air master with leather handle.

Misure/Sizes

100 - 110 - 120 cm

Colori/Colors

■ black I 001



Umbria
EQUITAZIONE

art VA01320

Descrizione/Features

Frustino dressage in nylon con manico in gomma modello Hoof.
Nylon dressage whip type hoof with horse hoof handle.

Misure/Sizes

110 - 120 cm

Colori/Colors

■ black I 001
■ brown I 010



Umbria
EQUITAZIONE

art VA01312

Descrizione/Features

Frustino dressage in fiberglass con manico pelle e flap in cuoio.
Fiberglass dressage whip with leather handle and leather flap.

Misure/Sizes

100 - 110 - 120 cm

Colori/Colors

■ black I 001



Umbria
EQUITAZIONE

art VA00215

Descrizione/Features

Frustino dressage in nylon manico pelle modello leather flying.
Nylon dressage whip type leather flying with leather handle.

Misure/Sizes

110 - 120 cm

Colori/Colors

■ black I 001

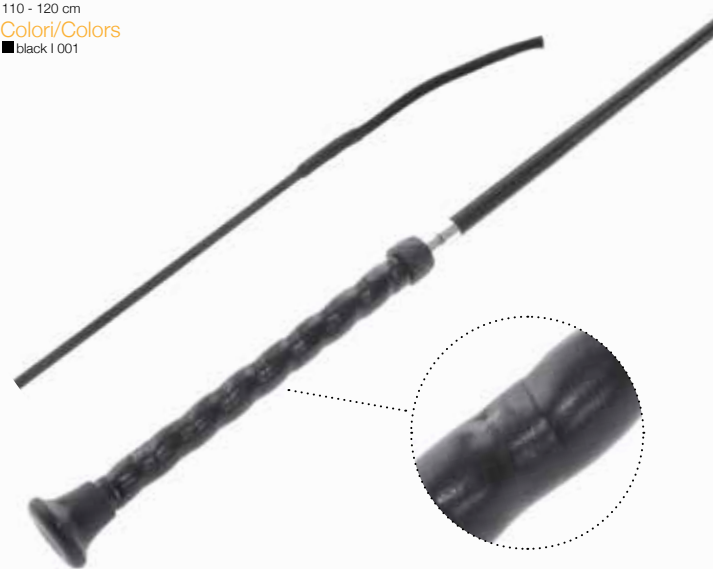

Fruste e Frustini - Whips

Dressage

art VA00278



Descrizione/Features

Frustino dressage con manico in pelle.
Nylon dressage whip with leather handle.

Misure/Sizes
100 - 110 - 120 cm

Colori/Colors

- black-silver I 089
- black-gold I 106



art VA00279

Descrizione/Features

Frustino dressage in nylon con manico grip.
Nylon dressage whip with non-slip rubber handle.

Misure/Sizes
100 - 110 - 120 cm

Colori/Colors

- black I 001
- white I 002
- silver I 019
- gold I 030

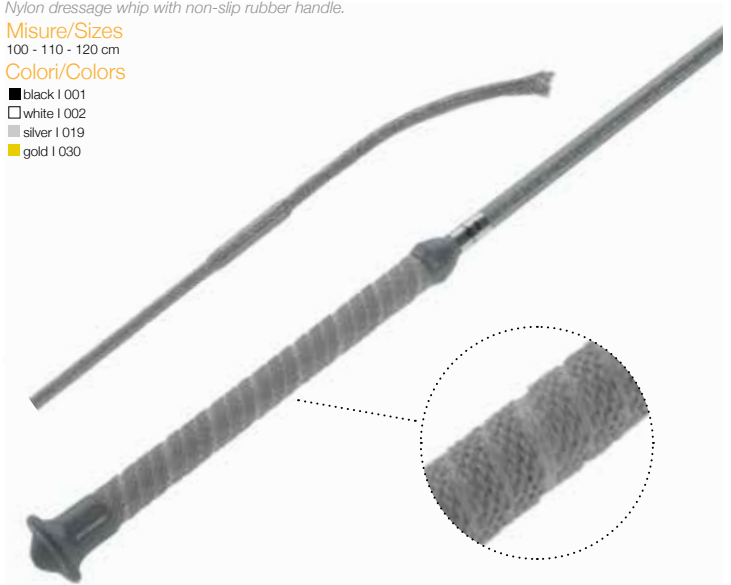

art VA00287B



Descrizione/Features

Frustino dressage in nylon con manico grip.
Nylon dressage whip with non-slip rubber handle.

Misure/Sizes
100 - 110 - 120 cm

Colori/Colors

- black-silver I 089
- black-gold I 106



art VA01314

Descrizione/Features

Frustino dressage in nylon colorato con manico grip. Venduto in set da 10 pezzi.
Nylon colored dressage whip with glitter non-slip rubber handle.

Colori/Colors
come catalogo/as catalogue

Misure/Sizes
110 - 120 cm



Set
10pz.

art VA01310



Descrizione/Features

Frustino dressage con manico grip modello bamboo finishes.
Bamboo finishes dressage whip with non-slip rubber handle.

Colori/Colors
come catalogo/as catalogue

Misure/Sizes
100 - 110 - 120 cm



art VA01311

Descrizione/Features

Frustino dressage con manico bicolore grip+pelle.
Nylon dressage whip with non-slip rubber handle.

Colori/Colors
come catalogo/as catalogue

Misure/Sizes
100 - 110 - 120 - 130 cm



Umbria
equitazione srl
Official

Umbria
EQUITAZIONE

art VA00284

Descrizione/Features

Frustino dressage con manico bianco.
Nylon dressage whip with white handle.

Colori/Colors

come catalogo/as catalogue

Misure/Sizes

100 - 110 - 120 cm



Umbria
EQUITAZIONE

art VA00216

Descrizione/Features

Frustino dressage con manico anti-slip e bottone argento.
Nylon dressage whip with non-slip rubber handle.

Colori/Colors

come catalogo/as catalogue

Misure/Sizes

110 - 120 cm

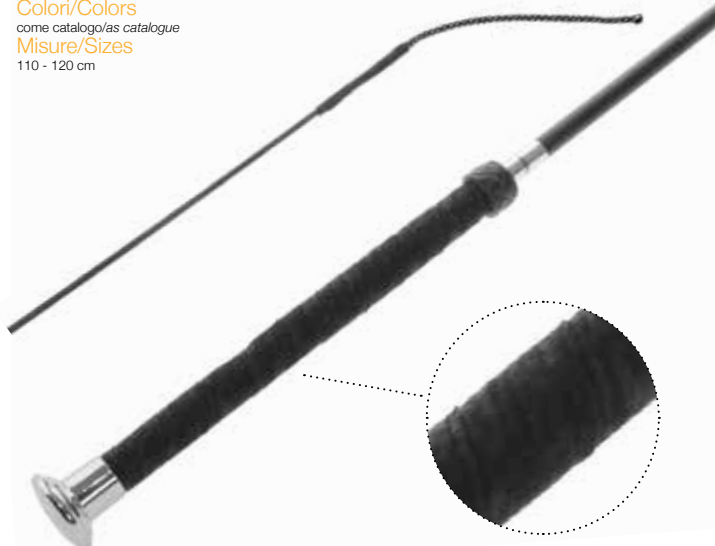

Umbria
equitazione srl
Official

www.umbriaequitazione.com

213

Umbria
EQUITAZIONE

art VA00217

Descrizione/Features

Frustino dressage manico anti-slip con strass e bottone argento flying.
Nylon dressage whip with non-slip handle with strass.

Colori/Colors

come catalogo/as catalogue

Misure/Sizes

110 - 120 cm



Umbria
EQUITAZIONE

art VA00218

Descrizione/Features

Frustino dressage carbon black matt con manico anti-slip bottone argento.
Carbon matt look dressage whip with non-slip handle.

Colori/Colors

come catalogo/as catalogue

Misure/Sizes

110 - 120 cm



Umbria
EQUITAZIONE

art VA00236

Descrizione/Features

Frustino dressage in nylon con manico cuoio e bottone modello superior.
Nylon dressage whip with leather handle.

Misure/Sizes

110 - 120 cm

Colori/Colors

■ black I 001

■ black-white I 098



Umbria
EQUITAZIONE

art VA00237

Descrizione/Features

Frustino dressage in nylon con manico cuoio e bottone argento modello superior.
Nylon dressage whip with leather handle.

Misure/Sizes

110 - 120 cm

Colori/Colors

■ black-white I 098

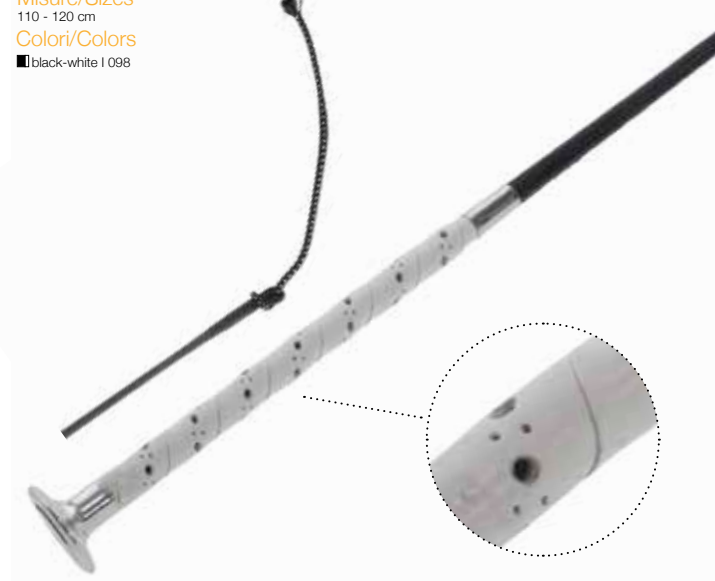

Fruste e Frustini - Whips

Dressage

Lungging

160
cm

art DM00090

Descrizione/Features
Frusta da tondino in nylon.
Nylon lunge whip.

Colori/Colors

- black I 001
- red I 003
- green I 005
- royal blue I 008
- yellow I 007

180
cm

art DM00090A

Descrizione/Features
Frusta da tondino in nylon.
Nylon lunge whip.

Colori/Colors

- black I 001
- red I 003
- green I 005
- royal blue I 008
- yellow I 007

180
cm

160
cm

170
cm

200
cm

art DM00090D

Descrizione/Features
Frusta da carrozza in nylon.
Driving whip.

Colori/Colors

- black I 001

art DM00090C

Descrizione/Features
Frusta da carrozza con punta bianca.
Driving whip.

Colori/Colors

- black I 001

Misure/Sizes

170 cm

art DM00090CL

Descrizione/Features
Frusta da carrozza con punta bianca.
Driving whip.

Colori/Colors

- black I 001

Misure/Sizes

200 cm

art DM00090B

Descrizione/Features
Frusta da tondino in nylon smontabile.
2-section lunge whip.

Colori/Colors

- black I 001

150
cm

art DM00089A

Descrizione/Features

Frustra carrot stick rigida con punta in cuoio.
Carrot stick.

Colori/Colors

- black I 001
- red I 003
- orange I 013



240
cm

art DM00102

Descrizione/Features

Frustra telescopica con manico pelle.
Telescopic hollow lunge whip.

Colori/Colors

- black I 001



150
cm

art DM00200

Descrizione/Features

Frustra da carrozza in legno e corda.
Wooden driving whip.

Colori/Colors

come catalogo/as catalogue



150
cm

art DM00200C

Descrizione/Features

Frustra da carrozza in legno e budello.
Wooden driving whip.

Colori/Colors

come catalogo/as catalogue



200
cm

art DM00103

Descrizione/Features

Frustra da tondino carbon con manico grip
Hollow lunge whip.

Colori/Colors

come catalogo/as catalogue



art DM00400



Descrizione/Features

Frustra in cuoio intrecciato e manico legno.
Braided leather with wooden handle whip.

Colori/Colors

- black I 001
- brown I 010



art DM00417



Descrizione/Features

Frustino da barrel intrecciato cuoio+rawhide.
Braided leather and rawhide barrel whip.

Colori/Colors

- black I 001
- brown I 010



art DM00410



Descrizione/Features

Frustino da barrel intrecciato in cuoio.
Braided leather barrel whip.

Colori/Colors

- black I 001
- brown I 010



art DM00412



Descrizione/Features

Frustino da barrel in rawhide intrecciato con punta cuoio.
Braided rawhide barrel whip with leather flap.

Colori/Colors

come catalogo/as catalogue



art DM00411



Descrizione/Features

Frustino da barrel in nylon con punta cuoio.
Braided nylon barrel whip with leather flap.

Colori/Colors

varti/various



art DM00202



Descrizione/Features

Frustra in nylon intrecciato con manico lungo.
Braided nylon whip with long wooden handle.

Colori/Colors

come catalogo/as catalogue

Misure/Sizes

290 cm



art PR00115

Descrizione/Features

Paraglomi chiusi in gomma naturale. Venduti in coppia.
Rubber bell boots. Sold in pairs.

Misure/Sizes
S - M - L - XL

Colori/Colors
■ black I 001
□ white I 002



art PR00114

Descrizione/Features

Paraglomi chiusi in caucciù. Venduti in coppia.
Transparent rubber bell boots. Sold in pairs.

Misure/Sizes
S - M - L - XL

Colori/Colors
come catalogo/as catalogue



218

www.umbriaequitazione.com



Umbria
equitazione srl
Official

art PR00115A

Descrizione/Features

Paraglomi in gomma naturale con chiusura velcro. Venduti in coppia.
Rubber bell boots with velcro. Sold in pairs.

Misure/Sizes
S - M - L - XL - XXL

Colori/Colors
■ black I 001
□ white I 002



art PR00111

Descrizione/Features

Paraglomi in gomma naturale con chiusura a cinturino. Venduti in coppia.
Lockabell rubber bell boots. Sold in pairs.

Misure/Sizes
S - M - L - XL

Colori/Colors
■ black I 001
□ white I 002



Protezioni - Protections

art PR00910

Descrizione/Features

Paraglomi anatomici in Gel Active. Venduti in coppia.
Active gel anatomic bell boots. Sold in pairs.

Misure/Sizes
M - L

Colori/Colors
■ black I 001



art PR00117

Descrizione/Features

Paraglomi in cordura antistrappo con interno in neoprene e sistema anti-rotazione. Venduti in coppia.
Cordura ripstop bell boots with neoprene protecting padding and No-turn system. Sold in pairs.

Misure/Sizes
S - M - L - (XL - XXL - XXXL solo nero/only black)

Colori/Colors
■ black I 001
□ white I 002
■ red I 003
■ royal blue I 008



ANATOMIC
**Hoof Gel
Boots**



Cordura
bell boots



noTurn
System



La proprietà dei materiali concepiti con tecnologia "AirFlow" è quella di presentare degli spazi vuoti nella loro struttura. Essi favoriscono la libera circolazione dell'aria, creando dei flussi che permettono una traspirazione naturale e continua.
The properties of materials designed with "AirFlow" technology is to present hollow spaces in their structure. They allow air circulation, creating flows that enable natural and continuous breathability.

Umbria
EQUITAZIONE

art PR00080

Descrizione/Features

Paratendini in neoprene con rinforzo in plastica e chiusura in velcro. Venduti in coppia.
Tendon boots with plastic outshell, neoprene protective padding and velcro closure. Sold in pairs.

Misure/Sizes

S - M - L

Colori/Colors

■ black I 001



Umbria
EQUITAZIONE

art PR00081

Descrizione/Features

Paranocche in neoprene con rinforzo in plastica e chiusura in velcro. Vendute in coppia.
Fetlock boots with plastic outshell, neoprene protective padding and velcro closure. Sold in pairs.

Misure/Sizes

S - M - L

Colori/Colors

■ black I 001



Umbria
equitazione srl
Official

www.umbriaequitazione.com

219

Protezioni - Protections

Umbria
EQUITAZIONE

art PR00094

Descrizione/Features

Stinchiere in neoprene con rinforzo in plastica e chiusura in velcro. Vendute in coppia.
Galloping boots with plastic outshell, neoprene protective padding and velcro closure. Sold in pairs.

Misure/Sizes

S - M - L

Colori/Colors

■ black I 001

■ red I 003



Umbria
EQUITAZIONE

art PR00094A

Descrizione/Features

Paranocche in neoprene con rinforzo in plastica e chiusura in velcro. Vendute in coppia.
Fetlock boots with plastic outshell, neoprene protective padding and velcro closure. Sold in pairs.

Misure/Sizes

S - M - L

Colori/Colors

■ black I 001

■ red I 003



Umbria
EQUITAZIONE

art PR00041

Descrizione/Features

Stinchiere in neoprene con rinforzo in pelle e chiusura in velcro. Vendute in coppia.
Galloping boots with leather outshell, neoprene protective padding and velcro closure. Sold in pairs.

Misure/Sizes

S - M - L

Colori/Colors

■ black I 001

■ red I 003

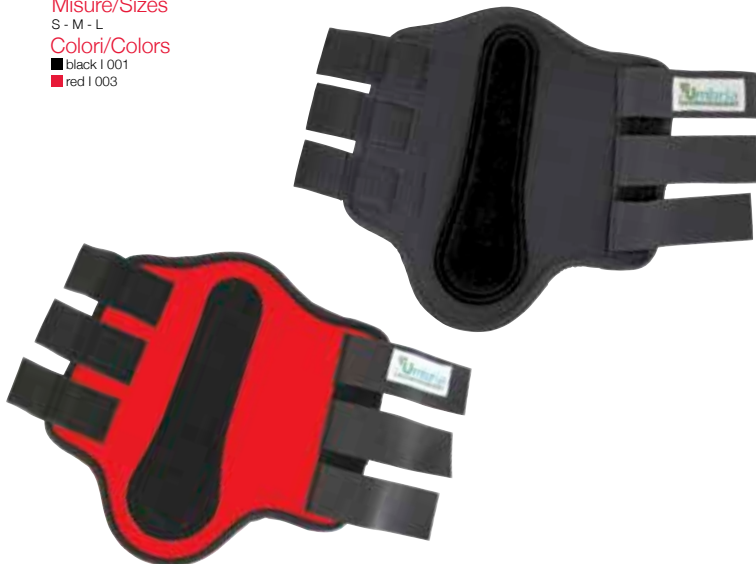

Umbria
EQUITAZIONE

art PR00041A

Descrizione/Features

Paranocche in neoprene con rinforzo in pelle e chiusura in velcro. Vendute in coppia.
Fetlock boots with leather outshell, neoprene protective padding and velcro closure. Sold in pairs.

Misure/Sizes

S - M - L

Colori/Colors

■ black I 001

■ red I 003



art PR00521



Descrizione/Features

Set paratendini e paranocche modello Air-Pro interno in neoprene e lycra traspirante, taglio anatomico, chiusure con doppio velcro. Confezionati in blister.

Anatomic tendon boots and fetlock boots type Air pro with plastic outshell, neoprene protective padding and lycra binding, velcro closure. Sold in plastic bag

Misure/Sizes

pony - full

Colori/Colors

- black I 001
- brown I 010



Set
4 pz.

Air-Pro

art PR00523



Descrizione/Features

Set paratendini e paranocche modello Air-Pro Carbon. Interno in neoprene ultratraspirante e rinforzi effetto carbon. Chiusure elastiche regolabili. Confezionati in blister.

Anatomic tendon boots and fetlock boots type Air pro Carbon with carbon-effect plastic outshell, neoprene protective padding and lycra binding, velcro closure. Sold in plastic bag

Misure/Sizes

full

Colori/Colors

- black I 001
- brown I 010
- light grey I 019



Set
4 pz.

Air-Pro Carbon

art PR00525



Descrizione/Features

Set paratendini e paranocche College edition con interno in neoprene e lycra traspirante, taglio anatomico, chiusure con doppio velcro. Confezionati in blister.

Anatomic tendon boots and fetlock boots type College edition with plastic outshell, neoprene protective padding and lycra binding, velcro closure. Sold in plastic bag

Misure/Sizes

full

Colori/Colors

- black I 001
- red I 003
- navy I 004
- white I 002
- burgundy I 006



Set
4 pz.

Colle

art PR00527



Descrizione/Features

Set paratendini e paranocche con interno in neoprene e rinforzo in plastica Mirage Collection. Set da 4 Pz. Confezionati in blister.

Anatomic tendon boots and fetlock boots type Mirage collection with plastic outshell, neoprene protective padding and lycra binding, velcro closure. Sold in plastic bag

Misure/Sizes

full

Colori/Colors

- royal blue I 008
- violet I 014
- yellow I 007
- green I 009
- orange I 013



Set
4 pz.

Mirage

art PR00529



Descrizione/Features

Set paratendini e paranocche con interno in neoprene e rinforzo in plastica Victory collection. Set da 4 Pz. Confezionati in blister.

Anatomic tendon boots and fetlock boots type Victory collection with plastic outshell, neoprene protective padding and lycra binding, velcro closure. Sold in plastic bag

Misure/Sizes

full

Colori/Colors

- navy I 004
- red I 003
- green I 009



Set
4 pz.

Victory

art PR00590



Descrizione/Features

Stinchiere da cross in neoprene forato con rinforzo in pelle e chiusure in velcro. Vendute in coppia Galloping boots with plastic outshell, neoprene protective padding and velcro closure. Sold in pairs.

Misure/Sizes

M - L

Colori/Colors

- black I 001



Cross
special



art PR00551

Descrizione/Features

Stinchiera in neoprene con rinforzo in pelle e chiusure con velcro. Vendute in coppia.
Galloping boots with leather outsheel, neoprene protective padding and velcro closure. Sold in pairs.

Misure/Sizes

S - M - L

Colori/Colors

■ black I 001
 □ white I 002



art PR00552

Descrizione/Features

Paraglomi in neoprene con rinforzo in pelle e chiusure con velcro. Venduti in coppia.
Neoprene bell boots with leather reinforcement and velcro closure. Sold in pairs.

Misure/Sizes

S - M - L

Colori/Colors

■ black I 001
 □ white I 002

**noTurn System**

Umbria
 equitazione srl
 Official



art PR00170X

Descrizione/Features

Stinchiere western anteriori in neoprene con chiusure in velcro. Vendute in coppia.
Neoprene western front boots with velcro closure. Sold in pairs.

Misure/Sizes

S - M - L

Colori/Colors

■ black I 001
 ■ red I 003
 ■ royal blue I 008
 □ white I 002



anteriore/front



art PR00170AX

Descrizione/Features

Stinchiere western posteriori in neoprene con chiusure in velcro. Vendute in coppia.
Neoprene western hind boots with velcro closure. Sold in pairs.

Misure/Sizes

S - M - L

Colori/Colors

■ black I 001
 ■ red I 003
 ■ royal blue I 008
 □ white I 002



posteriore/hind



art PR00119X

Descrizione/Features

Paraglomi western in neoprene con chiusure in velcro. Venduti in coppia.
Neoprene No-turn bell boots. Sold in pairs.

Misure/Sizes

S - M - L

Colori/Colors

■ black I 001
 ■ red I 003
 ■ royal blue I 008
 □ white I 002



art PR00191X

Descrizione/Features

Combination Boots in neoprene con chiusure in velcro. Venduti in coppia.
Neoprene western combination boots with velcro closure. Sold in pairs.

Misure/Sizes

S - M - L

Colori/Colors

■ black I 001
 ■ red I 003
 ■ royal blue I 008
 □ white I 002



art PR00168X

Descrizione/Features

Skid Boots western in neoprene con chiusure in velcro e rinforzo in plastica. Venduti in coppia.
Neoprene skid boots with velcro closure and plastic reinforcement. Sold in pairs.

Misure/Sizes

S - M - L

Colori/Colors

■ black I 001
 ■ red I 003
 ■ royal blue I 008
 □ white I 002



art PR00187

Descrizione/Features

Paragarretti in neoprene con chiusure in velcro. Venduti in coppia.
Neoprene hock boots with velcro closure. Sold in pairs.

Misure/Sizes

full

Colori/Colors

■ black I 001
 ■ red I 003
 ■ royal blue I 008



pro^{***}tech**
Horse Boots

PERFECT DRYING
AIRFLOW

La proprietà dei materiali concepiti con tecnologia "AirFlow" è quella di presentare degli spazi vuoti nella loro struttura. Essi favoriscono la libera circolazione dell'aria, creando dei flussi che permettono una traspirazione naturale e continua.

The properties of materials designed with "AirFlow" technology is to present hollow spaces in their structure. They allow air circulation, creating flows that enable natural and continuous breathability.



Descrizione/Features

Stinchiere X-Fit anteriori in neoprene con chiusure in velcro. Anatomiche e traspiranti con sistema di aerazione AirFlow. Vendute in coppia.

Anatomic X-fit western front boots with velcro closure. High transpiration with AirFlow ventilation system. Sold in pairs.

Misure/Sizes

Small - Medium - Large

Colori/Colors

- black I 001
- navy blu I 004
- red I 003
- burgundy I 006
- royal blue I 008
- green I 005
- white I 002

X-Fit
horse boots



Descrizione/Features

Stinchiere X-Fit posteriori in neoprene con chiusure in velcro. Anatomiche e traspiranti con sistema di aerazione AirFlow. Vendute in coppia.

Anatomic X-fit western hind boots with velcro closure. High transpiration with AirFlow ventilation system. Sold in pairs.

Misure/Sizes

Small - Medium - Large

Colori/Colors

- black I 001
- navy blu I 004
- red I 003
- burgundy I 006
- royal blue I 008
- green I 005
- white I 002

X-Fit
horse boots



Umbria
equitazione srl
Official

Descrizione/Features

Combination Boots in neoprene con chiusure in velcro. Anatomiche e traspiranti con sistema di aerazione AirFlow. Vendute in coppia.

Anatomic X-fit western combination boots with velcro closure. High transpiration with AirFlow ventilation system. Sold in pairs.

Misure/Sizes

Medium - Large

Colori/Colors

- black I 001
- royal blue I 008
- red I 003

Combination
horse boots



Descrizione/Features

Dynamic Skid Boots in neoprene con rinforzo in pelle e plastica. Anatomiche e traspiranti con sistema di aerazione AirFlow. Chiusure in velcro. Vendute in coppia.

Anatomic X-fit western Dynamic skid boots with velcro closure and leather and plastic reinforcement. High transpiration with AirFlow ventilation system. Sold in pairs.

Misure/Sizes

Small - Medium - Large

Colori/Colors

- black I 001
- navy blu I 004
- red I 003
- burgundy I 006
- royal blue I 008
- green I 005
- white I 002

Dynamic
skid boots



art PR00119



Descrizione/Features

Paragolmi Performa BB in neoprene con chiusure in velcro. Anatomici e traspiranti con sistema di aerazione AirFlow. Venduti in coppia.
Neoprene Performa bell boots with velcro closure. High transpiration with AirFlow ventilation system. Sold in pairs.

Misure/Sizes

Small - Medium - Large

Colori/Colors

- black I 001
- navy blu I 004
- red I 003
- burgundy I 006
- royal blue I 008
- green I 005
- white I 002

Performa
bell boots



art PR00193



Descrizione/Features

Ginocchiere per cavalli in neoprene con chiusure in velcro. Anatomiche e traspiranti con sistema di aerazione AirFlow. Vendute in coppia.
Neoprene horse knee boots with velcro closure. High transpiration with AirFlow ventilation system. Sold in pairs.

Misure/Sizes

unica/one size

Colori/Colors

- black I 001



art PR00020



Descrizione/Features

Fasce in neoprene traspiranti. Complete di sottofasce in cotone imbottite. Chiusure in velcro. Vendute in coppia.
High transpiration neoprene stable wraps with velcro closure. Complete with padded bandage pad. Sold in pairs.

Misure/Sizes

Small - Medium - Large

Colori/Colors

- black I 001
- navy I 004



art PR00512



Descrizione/Features

Fasce in neoprene traspiranti complete di sottofasce in cotone imbottite. Chiusure in velcro. Vendute in set da 4 pz. (anteriori+posteriori).
High transpiration neoprene stable wraps with velcro closure. Complete with padded bandage pad. Sold in set of 4. (front and hind)

Misure/Sizes

unica/one size

Colori/Colors

- black I 001

Set
4 pz.



art AB00318



Descrizione/Features

Fascia per la schiena con chiusure regolabili in velcro. Anatomiche e traspiranti con sistema di aerazione AirFlow. Ottima per alleviare i dolori alla schiena causati da lunghi periodi di seduta in sella.
Neoprene low back support with adjustable velcro closure. High transpiration with AirFlow ventilation system. Great for relieving tight or sore backs due to heavy lifting, sitting or riding for long periods of time.

Misure/Sizes

S - M - L - XL

Colori/Colors

- black I 001



art VA00423



Descrizione/Features

Paracoda in neoprene con chiusure in velcro. Anatomico e antiscivolo con doppia imbottitura nella parte superiore. Sistema di aerazione AirFlow. Venduto in confezione singola.
Neoprene anatomic and anti-slip tail wrap with velcro closure. Double padding reinforcement. AirFlow ventilation system. Sold in single package.

Misure/Sizes

unica/one size

Colori/Colors

- black I 001
- navy blu I 004
- red I 003
- burgundy I 006
- royal blue I 008
- green I 005
- white I 002



LAKOTA
SADDLERY CO. LA

art VA00422

Descrizione/Features

Paracoda in neoprene con chiusure in velcro. Venduto in confezione singola.
Neoprene tail wrap with velcro closure. Sold in single package.

Misure/Sizes

unica/one size

Colori/Colors

- black I 001
- white I 002
- burgundy I 006
- navy blu I 004
- pink I 011
- royal blue I 008
- green I 005



Umbria
EQUITAZIONE

art VA00421

Descrizione/Features

Paracoda in neoprene con chiusura in velcro. Venduto in confezione singola.
Neoprene tail wrap with velcro closure. Sold in single package.

Misure/Sizes

unica/one size

Colori/Colors

- black I 001



Umbria
equitazione srl
Official

www.umbriaequitazione.com

225

Protezioni - Protections

DAVIS
MEG INC.

art PR00613

Descrizione/Features

Paracoda in neoprene Davis con chiusura in velcro. Venduto in confezione singola.
Davis neoprene tail wrap with velcro closure. Sold in single package.

Misure/Sizes

unica/one size

Colori/Colors

- black I 001



Umbria
EQUITAZIONE

art VA00420

Descrizione/Features

Paracoda imbottito con laccio regolabile e chiusura in velcro. Venduto in confezione singola.
Padded tail guard with adjustable band and three velcro closure. Sold in single package.

Misure/Sizes

unica/one size

Colori/Colors

- black I 001
- burgundy I 006
- navy blu I 004
- green I 005



AMI-CELL

art VA00424

Descrizione/Features

Paracoda imbottito con laccio regolabile e chiusure in velcro. Venduto in confezione singola.
Padded tail guard with adjustable band and three velcro closure. Sold in single package.

Misure/Sizes

unica/one size

Colori/Colors

- black I 001
- burgundy I 006
- navy blu I 004
- green I 005



LAKOTA
SADDLERY CO. LA

art VA00425

Descrizione/Features

Paracoda imbottito con sacca e chiusura in velcro. Venduto in confezione singola.
Padded tail guard with bag and three velcro closure. Sold in single package.

Misure/Sizes

unica/one size

Colori/Colors

- black I 001
- red I 003
- navy blu I 004
- green I 005



art PR00010



Descrizione/Features

Fascia da riposo con chiusura in velcro. Venduta in set da 4 pezzi.
Knitted bandages with velcro closure. Sold in set of 4 pieces.

Misure/Sizes

4 Mt lunghezza/length - 10 cm altezza/height

Colori/Colors

come catalogo/as catalogue

Set
4pz



grey I 016



art PR00010B



Descrizione/Features

Fascia da riposo con chiusura in velcro. Venduta in set da 4 pezzi.
Knitted bandages with velcro closure. Sold in set of 4 pieces.

Misure/Sizes

4 Mt lunghezza/length - 11,5 cm altezza/height

Colori/Colors

come catalogo/as catalogue

Set
4pz



navy I 004



art PR00018



Descrizione/Features

Fascia pile + elastico con chiusura in velcro. Venduta in set da 4 pezzi.
Combination bandages (fleece+elastic) with velcro closure. Sold in set of 4 pieces.

Misure/Sizes

4 Mt lunghezza/length - 10 cm altezza/height

Colori/Colors

come catalogo/as catalogue

Set
4pz



red I 003



art PR00023



Descrizione/Features

Fascia in pile con chiusura in velcro. Venduta in set da 4 pezzi.
Polar fleece bandages with velcro closure. Sold in set of 4 pieces.

Misure/Sizes

4 Mt lunghezza/length - 10 cm altezza/height (7,5 cm PR00023P)

Colori/Colors

come catalogo/as catalogue

Set
4pz



yellow I 007



Disponibile anche da pony (art. PR00023P)
Available also in pony size (art. PR00023P)

art PR00022



Descrizione/Features

Fascia elastica da lavoro con chiusura in velcro. Venduta in set da 4 pezzi.
Elastic bandages with velcro closure. Sold in set of 4 pieces.

Misure/Sizes

4 Mt lunghezza/length - 10 cm altezza/height

Colori/Colors

come catalogo/as catalogue

Set
4pz



green I 005



art PR00514



Descrizione/Features

Fascia pile + elastico con chiusura in velcro. Venduta in set da 4 pezzi.
Combination bandages (fleece+elastic) with velcro closure. Sold in set of 4 pieces.

Misure/Sizes

3,5 Mt lunghezza/length - 10 cm altezza/height

Colori/Colors

come catalogo/as catalogue

Set
4pz



black I 001



art PR00013



Descrizione/Features

Fascia adesiva per medicazioni vetrap. Venduta in confezione singola.
Vetrap 3M cohesive bandage. Sold in single package.

Misure/Sizes

4,5 Mt lunghezza/length - 10 cm altezza/height

Colori/Colors

come catalogo/as catalogue



black I 001



art PR00013A



Descrizione/Features

Fascia adesiva per medicazioni. Venduta in confezione singola.
Cohesive bandage. Sold in single package.

Misure/Sizes

4,5 Mt lunghezza/length - 10 cm altezza/height

Colori/Colors

come catalogo/as catalogue



black I 001

white I 002





art PR00509

Descrizione/Features

Fascia in pile con chiusura in velcro Diamond collection. Venduta in set da 4 pezzi.
Polar fleece bandages type Diamond collection with velcro closure. Sold in set of 4 pieces.

Misure/Sizes

3,5 Mt lunghezza/length - 11 cm altezza/height

Colori/Colors

come catalogo/as catalogue



art PR00508

Descrizione/Features

Fascia in pile con chiusura in velcro Flower Lily collection. Venduta in set da 4 pezzi.
Polar fleece bandages type Flower Lily collection with velcro closure. Sold in set of 4 pieces.

Misure/Sizes

3,5 Mt lunghezza/length - 11 cm altezza/height

Colori/Colors

come catalogo/as catalogue



Umbria
equitazione srl
Official

www.umbriaequitazione.com

227

Protezioni - Protections



art PR00008

Descrizione/Features

Portafasce in nylon con cinghia regolabile.
Bandage carry-bag with adjustable strap.

Colori/Colors

- navy blu I 004
- burgundy I 006



art PR00006

Descrizione/Features

Portafasce in nylon con manico e chiusura zip.
Bandage carry-bag with hanger.

Colori/Colors

- navy blu I 004



art PR00039

Descrizione/Features

Avvolgi-fasce in metallo.
Metal quick bandage roller.



art PR00024



Descrizione/Features

Salvafasce chiodate con fibbie. Vendute in set da 2 pezzi.
Anti-bite boots. Sold in set of 2 pieces.

Colori/Colors

■ black I 001

Set
2 pz



art PR00012



Descrizione/Features

Set di 4 sottofasce in feltro. Misure: 1 40 x h 30 cm.
Felt bandage pad. Sold in set of 4 pieces. Measures: 1 40 x h 30 cm.

Colori/Colors

□ white I 002

Set
4 pz



art PR00014



Descrizione/Features

Set di 4 sottofasce in neoprene. Misure: 1 45 x h 30 cm.
Neoprene bandage pad. Sold in set of 4 pieces. Measures: 1 45 x h 30 cm.

Colori/Colors

■ black I 001

Set
4 pz



art PR00019



Descrizione/Features

Set di 4 sottofasce in feltro imbottite con gommapiuma. Misure: 2 pezzi 1 50 x h 45, 2 pezzi 1 45 x h 30 cm.
Padded bandage pad with felt on the inside side. Sold in set of 4 pieces.
Measures: 2 pieces 1 50 x h 45, 2 pieces 1 45 x h 30.

Colori/Colors

■ black I 001
□ white I 002

Set
4 pz



art PR00015



Descrizione/Features

Set di 4 sottofasce piccole in cotone imbottite. Misure: 1 40 x h 40 cm.
Padded bandage pad. Sold in set of 4 pieces. Measures: 1 40 x h 40 cm.

Colori/Colors

■ black I 001
■ navy I 004
■ burgundy I 006
□ white I 002
■ green I 005

Set
4 pz



art PR00015A



Descrizione/Features

Set di 4 sottofasce grandi in cotone imbottite. Misure: 1 60 x h 50 cm.
Padded bandage pad. Sold in set of 4 pieces. Measures: 1 60 x h 50 cm.

Colori/Colors

■ black I 001
■ navy I 004
■ burgundy I 006
□ white I 002
■ green I 005

Set
4 pz



art PR00510



Descrizione/Features

Set di 4 sottofasce in cotone imbottite. Misure: 1 65 x h 45 cm.
Padded bandage pad. Sold in set of 4 pieces. Measures: 1 65 x h 45 cm.

Colori/Colors

come catalogo/as catalogue

Set
4 pz



Descrizione/Features

Set di 4 paracolpi da trasporto imbottiti completi con paracoda. Chiusure in velcro.
Set of padded shipping boots with tail guard and velcro closure.

Misure/Sizes

full

Colori/Colors

- black I 001
- navy I 004
- burgundy I 006
- green I 005

Set
5 pz



Imbottitura con interno in cotone
Nylon outshell with cotton lining.



Umbria
equitazione srl
Official

protech

Descrizione/Features

Set di 4 paracolpi da trasporto imbottiti sagomati con chiusura in velcro.
Set of padded anatomic shipping boots with velcro closure.

Misure/Sizes

full

Colori/Colors

- black I 001
- navy I 004
- red I 003
- green I 005

Set
4 pz



Imbottitura con interno in pelliccia sintetica
Nylon outshell with synthetic fleece lining.



Umbria
EQUITAZIONE

Descrizione/Features

Set di 4 paracolpi da trasporto imbottiti sagomati con rinforzi in pelle sintetica. Tessuto antistrappo e chiusura in velcro.
Set of padded anatomic shipping boots with velcro closure and synthetic leather reinforces. Ripstop polyester.

Misure/Sizes

pony - cob - full

Colori/Colors

- black I 001
- navy I 004
- burgundy I 006
- green I 005

Set
4 pz



Comoda confezione con manici e chiusura zip
Sold in handy bag with handle and zipper closure.



art PR00036

Descrizione/Features

Set di 4 paracolpi da trasporto imbottiti sagomati con rinforzi in pelle. Tessuto antistrappo e chiusure in velcro.
 Set of padded anatomic shipping boots with velcro closure. Ripstop polyester.

Misure/Sizes

cob - full

Colori/Colors

come catalogo/as catalogue

stars I 088



Set
4 pz

Comoda confezione con manici e chiusura zip
 Sold in handy bag with handles and zipper closure.



230

www.umbriaequitazione.com

Protezioni - Protections

art PR00037

Descrizione/Features

Set di 4 paracolpi da trasporto imbottiti sagomati con rinforzi in pelle anatomica. Tessuto antistrappo e chiusure in velcro.
 Set of padded anatomic shipping boots with velcro closure and leather reinforces. Ripstop polyester.

Misure/Sizes

cob - full

Colori/Colors

- black I 001
- navy I 004
- burgundy I 006
- green I 005



Set
4 pz

Rinforzi in pelle con imbottitura anatomica
 Leather reinforces with anatomic padding



art PR00511

Descrizione/Features

Set di 4 paracolpi da trasporto imbottiti sagomati con rinforzi in pelle. Completi con paracoda. Tessuto antistrappo e chiusure in velcro.
 Set of padded anatomic shipping boots and tail guard with velcro closure and leather reinforces. Ripstop polyester.

Misure/Sizes

pony - cob - full

Colori/Colors

- black I 001
- navy I 004
- burgundy I 006



Set
5 pz

Comoda confezione con manici e chiusura zip
 Sold in handy bag with handles and zipper closure.



www.rghamicell.com

Leather Care - Cura del Cuoio

La sella e i finimenti hanno bisogno di una manutenzione costante e precisa, al fine di garantire una lunga durata e un comfort sempre intatto. Per questo motivo bisogna averne molta cura, facendo sempre attenzione anche alla pulizia.

The saddle and harness need constant maintenance and precise, in order to ensure a long life and a comfort always intact. For this reason, we must have great care, always being careful to clean also.



Grasso per cuoio: esercita un'azione idrorepellente. Rende il cuoio malleabile agendo come conservante.

Leather Grease: has a waterrepellent effect and makes leather smooth, gives it a well-cared for appearance and preserves it well.

Articolo Article	Contenuto Content
PU00050	500 ml.
PU00060	1000 ml.
PU00070	3000 ml.
PU00080	5000 ml.



Olio per cuoio: offre un trattamento di alta qualità per tutti i prodotti in cuoio rendendoli morbidi e curati.

Leather Oil: has a waterrepellent effect and makes leather smooth, gives it a well-cared for appearance and preserves it well.

Articolo Article	Contenuto Content
PU00090	500 ml.
PU00100	1000 ml.
PU00110	5000 ml.

Sapone per cuoio: pulisce, tratta e dà nuovo splendore al cuoio e alle selle. A base di glicerina. Saddle soap: clean and restore the natural condition of the leather. With a base of glycerine.

Articolo Article	Contenuto Content
PU00960	250 gr. barra bars
PU00500	500 ml.
PU00501	1000 ml.



Horse Care - Cura del Cavallo

Accudire il cavallo è un'attività basilare da svolgere con estrema competenza e preparazione. Un animale ben gestito sarà in perfetta forma e pronto ad eseguire ogni nostro comando con gioia e spensieratezza.

Horse Care is basic activity to be carried out with great skill and preparation. An animal will be well managed in perfect shape and ready for our every command with joy and happiness.



- **Grasso Giallo:** grasso neutro, il più utilizzato, protegge lo zoccolo da secchezza e screpolature. Yellow grease: neutral grease, the most commonly used protects the hoof from drying and cracking.
- **Grasso Verde:** grasso neutro con aggiunta di estratti vegetali per un maggior effetto antibatterico. Green grease: neutral grease with addition of vegetable extracts, for a greater antibacterial effect.
- **Grasso Nero:** grasso neutro con aggiunta di catramina per un miglior effetto antifungineo. Adatto nei periodi invernali. Black grease: neutral grease with the addition of catramina for a better antifungal effect. Suitable in winter.

Grasso per zoccoli: protegge dalla secchezza e dalle screpolature conferendo un aspetto curato allo zoccolo.
Hoof leather: protects the hoof against drying out and cracking. High quality laurel oil ensures healthy hoof growth, increases suppleness and gives the hoof a well-cared for appearance.

Articolo Article	Contenuto Content	Colori Colors
PU00010	500 ml.	● ● ●
PU00020	1000 ml.	● ● ●
PU00030	3000 ml.	● ● ●
PU00040	5000 ml.	● ● ●



Umbria
equitazione srl
Official

www.umbriaequitazione.com

233

Prodotti - Products



art PU00401

Shampoo per cavalli: Contiene un rivitalizzante per il pelo e dona un brillante aspetto setoso. Horse shampoo: cleans and conditions horse's coat and leaves it with a healthy shine.
[Contenuto/Content](#) 5000 ml.



art PU00400

Shampoo per cavalli: Contiene un rivitalizzante per il pelo e dona un brillante aspetto setoso. Horse shampoo: cleans and conditions horse's coat and leaves it with a healthy shine.
[Contenuto/Content](#) 1000 ml.

art PU00410

Shampoo a secco: Studiato per la pulizia del manto del cavallo senza uso di acqua. Particolarmente indicato per cavalli dal manto grigio, infatti ridona candore eliminando le antiestetiche macchie gialle. Dry lotion: a lotion formulated to cleaning the horse's coat without use of water. Particularly useful for the grey-coated horse.
[Contenuto/Content](#) 500 ml.



art PU00403

Shampoo alla Citronella: utilizzabile per il regolare lavaggio del cavallo, contiene un rivitalizzante per il pelo. Inoltre grazie alla sua profumazione alla citronella, aiuta a tenere lontani gli insetti. Citronella Shampoo: used for regular cleaning of the horse, contains a revitalizing hair. And thanks to its fragrance of lemon-grass, it helps to keep insects away.
[Contenuto/Content](#) 1000 ml.

art PU00350
Crema per ragadi: conferisce una eccezionale azione disinfiammante aumentando le difese fagocitarie, stimolando il sistema nervoso periferico. Scudo: makes a great action-inflammatory by increasing the phagocytic defenses by stimulating the peripheral nervous system.
Contenuto/Content
 500 gr.



art PU00750
Gel rinfrescante: applicato direttamente sugli arti, dona un immediato sollievo legato all'azione rinfrescante del mentolo e quella reidratante della glicerina. Flex Gel: applied directly on the legs, contribute to give immediate relief to the action of menthol refreshing and moisturizing action of glycerin.
Contenuto/Content
 500 gr.

art PU00810
Catrame vegetale di pino: contribuisce alla protezione dello zoccolo mantenendo un ottimale stato di pulizia e rinforzando la forchetta e il fettone. TarPaste: top quality tar of high viscosity. Well tried substance for hoof care.
Contenuto/Content
 1000 gr.



art PU00800
Liquido del villate: previene e cura l'imputridimento dello zoccolo riducendo le problematiche di fettono maleodorante. Liquido del villate: prevents and treats hoof, reducing the problems of smelly frog.
Contenuto/Content
 500 ml.

Crema per corone: svolge un'azione rinforzante e ristrutturante delle cellule cornee favorendo la crescita dello zoccolo. Crema per corone: plays a strengthening and restructuring of the corneal cells favoring the growth of the hoof.
Contenuto/Content
 250 ml.

art PU00860

Flogestina grigia: cretata minerale ad azione lenitiva, utile come coadiuvante nei problemi degli arti del cavallo. Applicabile anche in presenza di ferite. Grey Poultice: Kaolin clay poultice and other natural ingredients with refreshing, tonic, lenitive action. Attenuates the problems due to intense athletic activity of horses.

Articolo Article	Contenuto Content
PU00820	1000 ml.
PU00830	4000 ml.

Flogestina rosa: cretata minerale ad azione lenitiva, utile come coadiuvante nei problemi degli arti del cavallo. Evitare l'applicazione in presenza di ferite. Pink Poultice: Kaolin clay poultice and other natural ingredients with refreshing, tonic, lenitive action. Attenuates the problems due to intense athletic activity of horses.

Articolo Article	Contenuto Content
PU00840	1000 ml.
PU00850	4000 ml.



Uptite: astringente, defaticante, una barriera naturale contro le infezioni. Da utilizzare in caso di traumi acuti a carico di arti, tendini, legamenti e articolazioni. Utilizzabile anche in presenza di ferite cutanee! Uptite: Astringent, winding, a natural barrier against infections. In case of acute trauma affecting the arts, tendons, ligaments and joints. You use even in the presence of cutaneous wounds!

Articolo Article	Contenuto Content
CC00100	2 kg. / 71 FL.OZ
CC00110	4,54 kg. / 160 FL.OZ
CC00120	9 kg. / 318 FL.OZ



Sali elettrolitici: prodotto bilanciato a base di elettroliti, vitamina E, Vitamina C ed, L-Glicina, in polvere, totalmente idrosolubile, studiato per la reidratazione del cavallo sottoposto ad intensa attività fisica.

Electrolyte energy: is a product containing essential electrolytes and vitamins in an amino acid and maltodextrine base. The supplementation of electrolytes salts is very important for the horses in training, because increases performances.

Articolo Article	Contenuto Content
PU00604	1000 g.
PU00602	3000 g.



www.umbriaequitazione.com

235

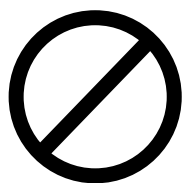

NO DOPING
Products



Dynamite: serve ad integrare in aminoacidi Ramificati lo sviluppo ed il nutrimento per i muscoli del cavallo. Vengono metabolizzati dai muscoli stessi e possono fornire energia utile specialmente nelle gare di durata.

Dynamite: used to integrate in branched amino acids the development and nourishment for the muscles of the horse. Are metabolized by the muscles themselves, and can provide useful energy especially in endurance racing.
[Contenuto/Content](#)
1000 g.

art PU00603

MSM (Metilsulfonilmetano): integratore alimentare studiato per il trattamento di riduzione delle cartilagini affette da artriti, riduzione della trasmissione dell'impulso del dolore, riduzione delle infiammazioni, dilatazione dei vasi sanguigni.

MSM (Metilsulfonilmetano): food supplement studied for the treatment of reduction of cartilage affected by arthritis, reduction of transmission of the pulse of pain, reducing inflammation, blood vessel dilation.
[Contenuto/Content](#)
1200 g.

art PU00741



art PU00622

Biotina: una pratica basilare per ridurre l'incidenza delle patologie podali. La sua presenza è fondamentale sia nella creazione e nello sviluppo del tessuto corneo dello zoccolo, che nella compattezza ed integrità dello stesso.

Biotin: Biotin is a complete food supplement for hoof growth and improved our integrity. Biotin stimulates keratin and hornu tissue production. Protects the hoof from cracks and brittleness.
[Contenuto/Content](#)
1000 g.

Mineralmix: è una miscela di sali ed oligoelementi in forma granulata studiata per risolvere il problema della polverosità tipica delle miscele di sali tradizionali. Grazie ad una sorgente di ferro ad alta disponibilità, è ideale per combattere forme di anemia.

Mineralmix: is a mixture of salts and trace elements in granulate form designed for solve the problem of dustiness of typical mixtures of traditional salts. Thanks to a source of high iron availability, it is ideal to combat forms of anemia.
[Contenuto/Content](#)
3000 g

art PU00601

Olio di fegato di merluzzo:

apportatore di energia da lipidi grezzi e di vitamine liposolubili. Indicato nel caso di convalescenze e nel recupero di soggetti debilitati, per donare lucentezza al mantello e come ricostituente generale.

Cod-Liver Oil:

source of energy from crude lipids and fat-soluble vitamins. Indicated in the case of convalescence and recovery of debilitated, to give luster to the coat and as a general tonic.

Articolo Article	Contenuto Content
PU00700	1000 ml.
PU00710	5000 ml.

art PU00653

Lievito di birra: apporto in aminoacidi capaci di migliorare e regolarizzare l'intestino, migliorando anche la lucidità del pelo dell'animale.

Lievito di birra: supply of amino acids that can improve and regularize the bowel, including improving the clarity of the hair of the animal.
[Contenuto/Content](#)
1000 g.

art PU00652

Broncotuss: opportunamente miscelato nella razione alimentare, migliora la respirazione e quindi l'ossigenazione muscolare.

Broncotuss: properly mixed in the feed ration, improves breathing and then muscle oxygenation.
[Contenuto/Content](#)
1000 ml.

Prodotti - Products

Aglione in scaglie: stimola la digestione, influisce beneficamente sul metabolismo ed inoltre aumenta le difese immunitarie contro le malattie. Con la sudorazione diffonde un odore che allontana gli insetti che pungono.

Garlic Flakes: stimulates digestion, has a beneficial effect on the metabolism and also increases your immunity against disease. With the perspiration diffuses an odor that repels insects that sting.

Articolo / Article	Contenuto / Content
PU00610	1000 g.
PU00612	5000 g.



art PU00730

Enzi-Max: miscela di minerali inorganici addizionati di ceppi batterici e miceli fungini atti a ridurre la proliferazione batterica e le esalazioni ammoniacali nella lettiera. Utile per prevenire patologie podali ed irritazioni alle mucose respiratorie.
Enzi-Max: mix of inorganic minerals with added bacterial strains and fungal mycelia acts to reduce bacterial growth and ammonia emissions in the litter. Useful to prevent pathology hoof and respiratory irritation to mucous membranes.
[Contenuto/Content](#)
4000 g.

Olio di aglio in capsule: ogni capsula contiene circa 8 mg di olio essenziale di aglio, corrispondente ad un grosso spicchio di aglio. L'uso dell'olio di aglio, rende il sudore del cavallo molto sgradevole agli insetti.
Garlic Pills: each capsule contains about 8 mg of garlic essential oil, corresponding to a large clove of garlic. The use of garlic oil, it makes the horse's sweat very unpleasant to insects.
[Contenuto/Content](#)
120 pillole-90 g./120 pils-90 g.

Aglione in polvere: stimola la digestione, influisce beneficamente sul metabolismo ed inoltre aumenta le difese immunitarie contro le malattie. Con la sudorazione diffonde un odore che allontana gli insetti che pungono.
Powder Garlic: stimulates digestion, has a beneficial effect on the metabolism and also increases your immunity against disease. With the perspiration diffuses an odor that repels insects that sting.
[Contenuto/Content](#)
1000 g.



art PU00740

Verstop: Prodotto coadiuvante per il trattamento dei parassiti intestinali del cavallo. Verstop sfrutta l'azione congiunta e complementare delle sostanze naturali al fine di un loro potenziamento per il raggiungimento dell'obiettivo desiderato.
Verstop: Product coadjuvant for the treatment of intestinal parasites of the horse. Verstop harnesses the combined and complementary action of natural substances with a view to their improvement for the achieving of the desired objective.
[Contenuto/Content](#)
90 g.

Animalintex: fascia per impacchi a caldo o freddo. Ideale nel trattamento delle ferite e un'ampia gamma di patologie, tra le quali quelle dello zoccolo.
Animalintex: all purpose veterinary poultice. Used hot: draws out infection and encourages healing Used cold: it will help to reduce swelling Can be used dry on clean open wound easy to prepare and use.
[Contenuto/Content](#)
1 fascia/ 1 bandage

art PR00007



art PU00802

HerbalTar: impedisce che agenti esterni presenti nella lettiera o nel fango, indeboliscano lo zoccolo (previene tarlo, marcimento del fettone, ecc.). Specialmente nella stagione invernale previene l'eccessiva umidità dell'unghia. HerbalTar è molto indicato per cavalli che vengono docciati frequentemente. Applicato dopo la ferratura crea una barriera protettiva ed aiuta la tenuta dei chiodi. Utilizzato regolarmente (una o due volte alla settimana) garantisce una condizione ottimale a muraglia, suola e fettone.
HerbalTar: stops external agent from stable bedding or paddock mud to weaken hoof (prevent white line disease, fork rotting, etc.). Especially during cold season it prevents excessive hoof moisture. Highly recommended for frequently showered horses. Applied after shoeing, it creates a protective barrier and grants firm grip of nails. Regular weekly use (once or twice a week) promotes ideal health conditions of hoof wall, frog and sole.
[Contenuto/Content](#)
400 ml.



art PU00803

Spray- Life: previene l'insorgere di funghi e batteri, si distingue dal classico unguento per la comoda confezione spray, rendendo l'applicazione pratica e veloce. Principalmente nei periodi secchi, applicato con regolarità (due volte alla settimana circa) garantisce la giusta elasticità dello zoccolo. Oltre ad esercitare un'azione idratante Spray-Life grazie al Tea Tree Oil, crea una barriera naturale agli agenti esterni. Il Tea Tree Oil, ricavato dalle foglie di Melaleuca Alternifolia, ha un alto potere fungicida. Consigliato dopo la ferratura.
Spray-Life: prevents formation of fungus and bacteria, works better than traditional ointments thanks to the handy spray bottle, allowing easy and quick application. Mainly during dry season, if applied regularly (approx twice a week) it guarantees hoof proper elasticity. Further to moisturizing hoof, Spray-Life also provides an ideal barrier against external agents thanks to Tea Tree Oil content. Tea Tree oil, extracted from Melaleuca leaves, has strong antifungal properties. Recommended after shoeing.
[Contenuto/Content](#)
400 ml.



art PU00804

Sos-Frog: il fettone, con la sua struttura gommosa, oltre ad avere un'azione ammortizzante, ha un importante ruolo nel meccanismo di dilatazione e contrazione dello zoccolo, fondamentale per garantire una buona circolazione agli arti del cavallo. In presenza di degradazione batterica Sos-Frog è il prodotto ideale per combattere questa patologia e ripristinare la sua importante funzione. In caso di marcimento del fettone, spruzzato regolarmente sulla parte interessata (due, tre volte la settimana) aiuta la ricrescita dei tessuti danneggiati. Sos-Frog è indicato inoltre in presenza di tarlo, ascessi e distaccamenti.
Sos-Frog: hoof frog, with the typical chewy texture, has a damping action as well as an important role in the mechanism of expansion and contraction of the hoof, crucial to ensure good circulation in horse's legs. In case of bacterial related degradation, Sos-Frog is the perfect product to heal bacterial related diseases and restore frog's natural function. In case of rotten frog, sprayed regularly on the affected part (two or three times a week) it promotes re-growth of damaged tissues. Sos-Frog is recommended in case of white line disease and hoof abscess.
[Contenuto/Content](#)
400 ml.



art PU00403

Shampoo alla Citronella: utilizzabile per il regolare lavaggio del cavallo, contiene un rivitalizzante per il pelo. Inoltre grazie alla sua profumazione alla citronella, aiuta a tenere lontani gli insetti. Shampoo alla Citronella: used for regular cleaning of the horse, contains a revitalizing hair. And thanks to its fragrance of lemongrass, it helps to keep insects away. [Contenuto/Content](#) 1000 ml.



art PU00300

Lozione Citronella e Geranio: spruzzata in leggere quantità sul cavallo, grazie alla presenza di olii concentrati di citronella e geranio aiuta a tenere lontano gli insetti. Lozione Citronella e Geranio: sprayed on the horse, thanks to the concentrated oils of citronella and geranium helps to keep insects away. [Contenuto/Content](#) 1000 ml.



Citronella

La citronella è una pianta erbacea facente parte del genere del Cymbopogon, dalla quale si estrae l'omonimo olio essenziale, un vero e proprio repellente in grado di allontanare insetti e fastidiose zanzare nella stagione estiva.

Citronella is a herbaceous plant belonging to the genus of Cymbopogon, from which we extract the essential oil of the same name, a real repellent able to ward off pesky mosquitoes and insects in summer.



Umbria equitazione srl Official

Shampoo

www.umbriaequitazione.com

237

Prodotti - Products

Geranio/*Geranium*

Il geranio è una pianta che contiene piretro naturale, e grazie al suo profumo ha il potere di allontanare le zanzare. La piretrina e i Piretroidi contenuti naturalmente in questa pianta, agiscono sul sistema nervoso degli insetti, allontanandoli. Ottimo rimedio quindi alla lotta contro questi parassiti, e soprattutto una lotta del tutto naturale.

The geranium is a plant that contains natural pyrethrum, and thanks to its scent has the power to ward off mosquitoes. Pyrethrin and Pyrethroids contained naturally in this plant, affect the nervous system of insects, moving them away. Excellent remedy for efforts to combat these pests, and first of all a struggle quite natural.

art PU00311

Gel alla Citronella e Geranio: spalmare un leggero quantitativo di gel sul cavallo, grazie alla presenza di olii concentrati di citronella e geranio aiuta a tenere lontano gli insetti. Gel alla Citronella e Geranio: spread a little amount of gel on the horse, thanks to the concentrated oils of citronella and geranium helps to keep insects away. [Contenuto/Content](#) 500 ml.



Roool-on alla Citronella: passare con l'apposita rotella nella zona da trattare, grazie alla presenza di olii concentrati di citronella e geranio aiuta a tenere lontano gli insetti. Roool-on alla Citronella: switch with the appropriate gear in the area to be treated, thanks to the concentrated oils of citronella and geranium helps to keep insects away. [Contenuto/Content](#) 50 ml.

art PU00310

art CC00311

Kenyafog: insetticida liquido pronto all'uso a base di piretro naturale per disinfestare stalle e allevamenti contro mosche, zanzare e insetti striscianti. Azione repellente, per trattamenti in presenza di animali.

Kenyafog: liquid insecticide ready to use natural pyrethrum to disinfect stables and farms against flies, mosquitoes and crawling insects. Repellent action, for treatments in the presence of animals. [Contenuto/Content](#) 5000 ml.



Kenyafog: insetticida liquido pronto all'uso a base di piretro naturale per disinfestare stalle e allevamenti contro mosche, zanzare e insetti striscianti. Azione repellente, per trattamenti in presenza di animali. Kenyafog: liquid insecticide ready to use natural pyrethrum to disinfect stables and farms against flies, mosquitoes and crawling insects. Repellent action, for treatments in the presence of animals. [Contenuto/Content](#) 1000 ml.

art CC00310



art CC00450

Sugarkill Extra: esca moschicida granulare a base di Acetamidrid con attrattivo sessuale ed attrattivo alimentare per il controllo delle mosche. Contiene sostanza amara anti ingestione. Sugarkill Extra: granular bait fly kill based Acetamidrid with sex attractant and attractive food for the control of flies. Contains anti bitter substance ingestion. [Contenuto/Content](#) 500 g.



art CC00410

Kenyasafe: insetticida a base di piretro e tetrametrina per applicazione con erogatori automatici Copymatic (CC00391) Kenyasafe: insecticide based on pyrethrum and tetramethrin for application with dispensers Automatic Copymatic (CC00391) [Contenuto/Content](#) 250 ml.



art CC00391

Copymatic Evolution: erogatore automatico programmabile per bombole aerosol automatizzate. Programmabile con tre intervalli di erogazione. Copymatic Evolution: Programmable automatic aerosol dispenser for automated with three spray intervals.



MOSCA'CLAC

NASTRO VISCHIOSO

KIT COMPLET 700 m nastro vischioso moschicida + accessori di montaggio



caratteristiche / features

Dispositivo professionale ecologico destinato alla lotta contro le mosche negli allevamenti. Sfrutta l'azione cromotropica del colore giallo verso le mosche riducendone il numero. Compatibile con i trattamenti insetticidi, risulta utile anche in caso di popolazioni con presenza di individui resistenti. Principali Caratteristiche: nastro di colore giallo - facile impiego - colla attiva sul 100% della superficie del nastro srotolato - privo di insetticidi.

Ecological professional device designed to combat the flies on farms. Use the chromotropic action of yellow flies towards reducing their number. Compatible with the insecticide treatments, is also useful in case of populations with the presence of resistant individuals. Main features: Yellow Ribbon - Easy to use - glue on 100% of the active surface of the tape unrolled - free of insecticides.

ambienti di applicazione / application environments

Ambienti zootecnici: stalle, box, ricoveri, sale di mungitura.
Zootechnical Environments: barns, garages, stables, milking rooms.

modalità di impiego / instructions for use

Il nastro collante deve essere disteso all'interno del locale prescelto seguendo una traiettoria che non sia di intralcio alle normali attività. Apposite carrucole (in dotazione) permettono i necessari cambi di direzione. Per ottenere un avvolgimento ottimale è necessario allineare l'ultima carrucola alla bobina vuota. Verificare periodicamente le catture e far scorrere il nastro ogni qual volta risulti pieno.

The adhesive tape must be lying inside the premises chosen following a trajectory that is not a hindrance to normal activities. Special pulleys (included) allow for the necessary changes in direction. To obtain an optimal winding is necessary to align the last pulley to the empty spool. Periodically check the catch and slide the tape whenever it appears full.

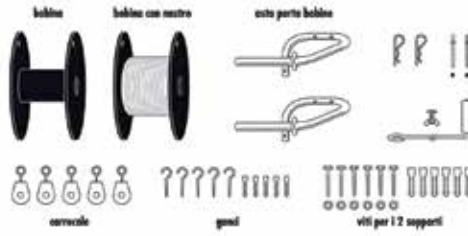

Mouch'Clac: nastro vischioso destinato alla protezione degli animali contro le mosche all'interno degli allevamenti. E' compatibile con i trattamenti insetticidi. Cattura sino a 500 mosche al metro.

Mouch'Clac: sticky tape for the protection of animals against flies in farms. It's compatible with insecticide treatments. Capture up to 500 flies per meter.

Contenuto/Content

kit completo per il montaggio ed una bobina da 700 mt.
Assembly kit and one reel of 700 mt.

art CC00315



Umbria equitazione srl Official

238

www.umbriaequitazione.com

Prodotti - Products

art CC00316

Nastro Mouch'Clac: nastro vischioso moschicida sostitutivo per kit Mouch'Clac (CC00315)
Nastro Mouch'Clac: fly control sticky tape replacement kit for Mouch'Clac (CC00315)



Arrotolare il nastro ogni 10-15 giorni (salvo saturazione di mosche in anticipo), al fine di rinnovare la superficie di cattura, in quanto la capacità adesiva diminuisce a causa della polvere.

Roll the tape every 10-15 days (except saturation of flies in advance) in order to renew the capture surface, since the adhesive capacity decreases due to the dust.

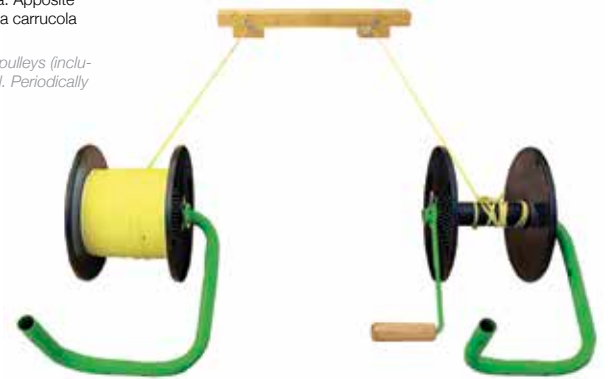

ISI TRAP

trappola per mosche
ECO-COMPATIBILE

ECO-COMPATIBILE fly trap

cosa serve / what you need

trappola/trap

acqua/water

La busta del preparato naturale in polvere anti-mosche
The envelope of the prepared natural in anti-dust flies



art PU00621

Esca attrattiva: busta di attrattivo per trappola antimosche (PU00620)
Bait attraction: envelope attractive to trap Fly (PU00620)

come fare / how to do

Versare semplicemente una busta in 3/4 litri di acqua, e chiudere il tappo trasparente (che permette di monitorare la situazione all'interno). La soluzione naturale emana un odore percepito dalle mosche, le quali vengono attratte all'interno del contenitore attraverso gli appositi coni traforati.

Put simply an envelope in 3/4 liters of water, and close the transparent cap (which allows you to monitor the situation inside). The natural solution gives off an odor perceived by flies, which are attracted into the container through the appropriate perforated cones.



Il risultato finale sarà.. / the final result will be..



art PU00620

Trappola antimosche: attrae le mosche dentro al secchio grazie ad un esca naturale, impedendone poi la fuoriuscita.
Fly Trap: attracts flies into the bucket thanks to a natural bait, then preventing the spill.
Contenuto/Content
secchio completo più due attrattivi / assembly kit and two attractive



art PU00211

Showsheen: lucidante e sgruvigliante, rende code e criniere lisce, senza grovigli. Respinge sporco, macchie e polvere. Showsheen: polishing and detangling, makes bones manes and tails tangle-free. It repels dirt, stains and dust.
Contenuto/Content 3,8 L / 1 Gallon



art PU00210

Showsheen: lucidante e sgruvigliante, rende code e criniere lisce, senza grovigli. Respinge sporco, macchie e polvere. Showsheen: polishing and detangling, makes bones manes and tails tangle-free. It repels dirt, stains and dust.
Contenuto/Content 946 ml. / 32 fl. oz.



art PU00200

Lozione lucidante e sgruvigliante: spray ad azione lucidante e sgruvigliante per criniera, coda e mantello. Conferisce al pelo una lucentezza setosa evitando la formazione di nodi ed infeltrimenti per una facilitata pettinatura. Lozione lucidante e sgruvigliante: spray polish and detangler for mane, tail and coat. It gives the hair a silky shine avoiding the formation of knots and felting for easy combing.
Contenuto/Content 1000 ml.



Umbria equitazione srl Official

www.umbriaequitazione.com

239

Prodotti - Products

art PU00680

Lactic Control

LACTIC CONTROL è una pasta gel studiata per contrastare la produzione degli acidi lattici. Va somministrato 5 ore prima della competizione. Contrasta le manifestazioni tipiche dell'accumulo di acido lattico, come rigidità e crampi muscolari. Contiene sodio citrato che favorisce la riserva alcalina dell'organismo.

LACTIC CONTROL is a paste gel designed to counteract the production of lactic acid. It should be administered five hours before the competition. Sharpens the typical manifestations of the 'accumulation of lactic acid, such as stiffness and muscle cramps. Contains sodium citrate which helps the alkaline reserve of the body.

Contenuto/Content 500 ml.

art PU00682

Malto Energy

Le maltodestrine sono carboidrati che danno energia ai muscoli in tempi brevissimi, non richiedono sforzi digestivi per entrare in circolo nel sangue. Aumenta il glicogeno muscolare (la benzina dei muscoli). Questo conferisce al cavallo una maggiore resistenza allo sforzo. Ideale per somministrare energia prima di importanti gare e/o duri allenamenti, non "scalda" il cavallo trattato.

The maltodextrins are carbohydrates that give energy to the muscles very quickly, do not require digestive efforts to enter the bloodstream. Increase your muscle glycogen (the fuel of the muscles). This gives the horse a greater resistance to stress. Ideal for delivering energy before major competitions and / or hard workouts, not "warm" the horse and sycamore.

Contenuto/Content 500 ml.

art PU00681

Elite K+

ELITE K+ è una miscela di sali elettrolitici in pasta gel per rifornire l'organismo dei sali persi con la sudorazione. Ideale quando sia richiesto un intervento molto rapido ed efficace: durante viaggi, gare di endurance, soggetti disidratati ecc. Molto indicato per i soggetti che non si abbeverano in quantità sufficienti. E' ben gradito grazie al sapore dolce conferito dallo sciroppo di sorbitolo.

ELITE K+ is a mixture of salts in the electrolyte gel paste to replenish body salts lost through sweating. Ideal when both operating very fast and effective during travel, endurance races, dehydrated etc.. Very suitable for people who do not drink in sufficient quantities. And 'well-liked thanks to the sweet taste conferred by the sorbitol syrup.

Contenuto/Content 500 ml.



NO DOPING products

art PU00680

Skincut: fitocomplesso vegetale ricco di sostanze naturali, coadiuvante in caso di riparazione cutanea, stimola l'equilibrio cutaneo e la particolare profumazione risulta sgradita agli insetti molesti. Skincut: phytocomplex vegetable rich in natural substances, assisting in case of repair of the skin, stimulates skin equilibrium and the particular scent is unwelcome to the troublesome insects.

Contenuto/Content 125 ml.

Equiprotect: ricco di sostanze naturali ed oli essenziali coadiuvante nel trattamento di dermatosi secche, squamose e ipercheratosiche, aiuta e velocizza il processo rigenerativo della cute. Coadiuvante in caso di ragadi, screpolature e fiaccature.

Equiprotect: It is an ointment rich in natural essences and essential oils, coadjuvant in the treatment of dry, scaly and hyperkeratotic dermatosis.

Contenuto/Content 250 ml.

art PU00655

Equitrauma: fitocomplesso vegetale ad alta concentrazione di principi attivi naturali. Attenua il dolore causato da contusioni, strappi, dolori artrici, tendiniti e distorsioni. Favorisce il riassorbimento di ematomi.

Equitrauma: phytocomplex plant with a high concentration of natural active ingredients. Relieves pain caused by bruises, tears, arthritic pain, tendonitis and sprains. It promotes the resorption of bruising.

Contenuto/Content 500 ml.

art PU00657

Equirelax: Fitocomplesso vegetale ad alta concentrazione di principi attivi naturali. Tonificante e rilassante dopo allenamenti e gare, indicato in situazioni di affaticamento degli arti, attenua la rigidità e le problematiche da stress e sforzo.

Equirelax: Phytocomplex plant with a high concentration of natural active ingredients. Invigorating and relaxing after training and competition, as indicated in situations of fatigue in the limbs, reduces the stiffness and problem of stress and strain.

Contenuto/Content 500 ml.

art PU00659

Equiderma: lozione fitosinergica a rilascio prolungato e protettivo. Rigenera e rivitalizza il tessuto cutaneo irritato, ripristina l'elasticità cutanea alleviando il prurito ed il dolore.

Equiderma: extended-release and protective synergistic lotion. Regenerates and revitalizes the skin tissue irritation, restores skin elasticity relieving itching and pain.

Contenuto/Content 1 l.



art PU00920

Snack per cavalli: biscotti per cavalli al gusto di banana, senza zucchero, conservanti e lievanti aggiunti.
Horses crunchies: banana crunchies, without sugar, preservatives and added leavening.
Contenuto/Content 950 gr.



art PU00903

Snack per cavalli: biscotti per cavalli al gusto di mela, senza zucchero, conservanti e lievanti aggiunti.
Horses crunchies: apple crunchies, without sugar, preservatives and added leavening.
Contenuto/Content 3000 g.



art PU00900

Snack per cavalli: biscotti per cavalli al gusto di mela, senza zucchero, conservanti e lievanti aggiunti.
Horses crunchies: apple crunchies, without sugar, preservatives and added leavening.
Contenuto/Content 1000 g.



art PU00913

Snack per cavalli: biscotti per cavalli al gusto di carota, senza zucchero, conservanti e lievanti aggiunti.
Horses crunchies: carrot crunchies, without sugar, preservatives and added leavening.
Contenuto/Content 3000 g.



art PU00910

Snack per cavalli: biscotti per cavalli al gusto di carota, senza zucchero, conservanti e lievanti aggiunti.
Horses crunchies: carrot crunchies, without sugar, preservatives and added leavening.
Contenuto/Content 950 g.



Mela - Apple

Banana

Carota - Carrot

Vaniglia e Cereali - Vanilla & Cereals

art PU00936

Delizia liquirizia: snack alla liquirizia, non cotti, con crusca di avena e crusca di grano. Gustoso e naturale.
Delizia liquirizia: licorice snack, uncooked, oat bran and wheat bran. Tasty and natural.
Contenuto/Content 930 g.



art PU00935

Delizia mela: snack alla mela, non cotti, con crusca di avena e crusca di grano. Gustoso e naturale.
Delizia apple: apple snack, uncooked, oat bran and wheat bran. Tasty and natural.
Contenuto/Content 930 g.

art PU00933

Snack per cavalli: biscotti per cavalli al gusto di vaniglia e cereali, senza zucchero, conservanti e lievanti aggiunti.
Horses crunchies: vanilla and cereals crunchies, without sugar, preservatives and added leavening.
Contenuto/Content 3000 g.



art PU00930

Snack per cavalli: biscotti per cavalli al gusto di vaniglia e cereali, senza zucchero, conservanti e lievanti aggiunti.
Horses crunchies: vanilla and cereals crunchies, without sugar, preservatives and added leavening.
Contenuto/Content 950 g.



Umbria
equitazione srl
Official

effax

leather care

art LE00290

Leder-Combi: sapone liquido formulato per essere utilizzato senza acqua, pulisce il cuoio senza lasciare residui oleosi, lasciando la pelle morbida ed elastica.
Leder-Combi: cleans and nourishes the leather fibre in a unique way, with a deep-penetrating effect, without making the leather greasy.
Contenuto/Content 500 ml.



art LE00270

Leder-Öl: olio per cuoio, offre un trattamento di alta qualità per tutti i prodotti in cuoio rendendoli morbidi e curati.
Leder-Öl: olio per cuoio, offre un trattamento di alta qualità per tutti i prodotti in cuoio rendendoli morbidi e curati.
Contenuto/Content 500 ml.



art LE00230

Grasso per cuoio: Un prodotto classico. Basta applicarlo sul cuoio dopo la pulizia. Con gli ingredienti derivanti da materie prime naturali e la presenza di vasellina, il cuoio riacquista la sua morbidezza e resistenza.
Leder-fett: Simply apply to the leather after cleaning. Has a re-greasing effect due to natural raw ingredients.
Contenuto/Content 500 ml.



art LE00240

Grasso per cuoio: Un prodotto classico. Basta applicarlo sul cuoio dopo la pulizia. Con gli ingredienti derivanti da materie prime naturali e la presenza di vasellina, il cuoio riacquista la sua morbidezza e resistenza. **Maggiornamento indicato per pellami di colore nero.**
Leder-Grease: Simply apply to the leather after cleaning. Has a re-greasing effect due to natural raw ingredients. Specified for black leather.
Contenuto/Content 500 ml.



art LE00210

Leder-Balsam: balsamo per cuoio, ammorbidisce, protegge e ripristina. Questo balsamo pelle è formulato con lanolina ed olio di avocado per aggiungere morbidezza alla pelle e con cera d'api per respingere l'umidità.
Leder-Balsam: extends the "lifespan" of the leather and is therefore used ardently all over the world. For durability and reliability of the leather equipment due to a combination of lanolin and caring oils.
Contenuto/Content 500 ml.



art LE00220

Leder-Soft: lozione ammorbidente per cuoio, restaura e conserva lasciando la pelle morbida e flessibile. Composto da una miscela di olio naturale di lanolina, olio di avocado e cera d'api, nutre, protegge ed aumenta la vita del cuoio.
Leder-Soft: As a result of the special mixture of lanolin and avocado oil, the leather becomes supple, tear-proof and soft. Bees' wax not only leaves a pleasant smell, it also gives a pleasant feel to the surface of the leather as well as protecting it against moisture.
Contenuto/Content 500 ml.



art LE00191

Leder-Creme: sapone per cuoio in pasta, pulisce e cura il cuoio in un unico passaggio senza l'utilizzo di acqua. Contiene: olio di avocado, olio di cocco e aloe vera.
Leder-Creme: The Effax Leather-Cream-Soap in the Flic-Flac bottle to turn and hang up. Cleans and cares for the water in one single step - quickly and simply with no water required.
Contenuto/Content 400 ml.

art LE00330

Wax Cotton: cera impermeabilizzante per tessuti, Effax-Wax Cotton è un prodotto speciale per la cura e la pulizia di giacche cerate. La cera può essere applicata facilmente con una spugna. Contiene: oli per la cura di cotone cerato, lanolina.
Wax Cotton: is a special product for the care and cleaning of wax jackets. The wax can be applied very easily with a sponge.
Contenuto/Content 200 ml.



art LE00390

Impra-Leder: impermeabilizzante per pelli lisce e scamosciate. Conserva tutte le caratteristiche del cuoio, compresa la traspirabilità ed ha un effetto idrorepellente ed antimacchia. Utilizzabile anche nelle combinazioni cuoio/tessuto.
Impra-Leder: Impregnation can be used for all-over impregnation purposes or for specific points only. It guarantees highest standards of impregnation and breathability and is extremely environmentally friendly. Ideal for follow-up impregnation whilst maintaining the leather functions and making it dirt-repellent, because it also keeps leather clothing and shoes supple and breathable.
Contenuto/Content 200 ml.



art LE00380

Impra-TEX: impermeabilizzante per tessuti, riveste le fibre ma non le ostruisce, permettendo una perfetta traspirazione anche nei tessuti più tecnici.
Impra-TEX: guarantees ultimate standards of impregnation and breathability. On account of its 360° spraying power, this product is simple, convenient and environmentally friendly in application as it functions on an air pressure basis and does not contain any propellant.
Contenuto/Content 200 ml.



art LE00300

Combi-Wash: prodotto per la cura del cuoio o delle combinazioni cuoio/tessuto. Mantiene la pelle morbida ed elastica.
Combi-Wash: keeps leather, particularly leather breeches, gloves and chaps, soft and supple and ensures that the form of the leather remains stable.
Contenuto/Content 250 ml.

art LE00310

Grip-Stick: di facile applicazione, grazie alla sua formula innovativa, applicato sul sedgio aiuta ad aumentare il grip con la sella per una migliore stabilità.
Grip-Stick: The Effax Leather Grip Stick gives the leather a firm and perfectly uncomplicated grip - all the time, everywhere.
Contenuto/Content 50 ml.



art LE00340

Boots Shine: sapone per superfici in gomma e plastica, pulisce e rimuove lo sporco ostinato. Nutre le superfici e dona gradualmente il colore originale.
Boots Shine: Cleans synthetic and rubber surfaces and removes stubborn dirt. It has a caring effect on the surfaces and gradually the full depth of colour is restored.
Contenuto/Content 100 ml.

art LE00311

Maul-Butter: protegge la bocca del cavallo con effetto "burro cacao". Il gusto di mela stimola l'attività di masticazione. Se applicato sul morso incoraggia il cavallo ad accettarlo meglio.

Maul-Butter: Meanwhile, to provide some more variety, which can also stimulate the chewing activity. The rich formula helps the bit to slide more easily into a comfortable position in the horse's mouth. Effol Mouth-Butter also protects even a sensitive mouth like a second skin and nourishes the particularly tender corners.

Contenuto/Content
150 ml.



art LE00312

Lippen-Butter: burro cacao per il cavaliere al gusto di mela.

Lippen-Butter: for chapped and dry lips.
Contenuto/Content
10 ml.

Efffol®

art LE00030

Huf-Salbe: questo grasso per zoccoli aiuta a garantire una crescita sana dello zoccolo, rafforzandolo e mantenendo la sua elasticità. Respinge lo sporco.

Huf-Salbe: Hoof-Ointment ensures healthy hoof growth and also has a disinfecting effect. The combination of laurel and thymol effectively helps to protect against hoof diseases. Vaseline forms a water-repellent and dirt-repellent film which protects the hoof against outside influences.

Contenuto/Content
500 ml.



Huf-Salbe: questo grasso per zoccoli aiuta a garantire una crescita sana dello zoccolo, rafforzandolo e mantenendo la sua elasticità. Respinge lo sporco.

Huf-Salbe: Hoof-Ointment ensures healthy hoof growth and also has a disinfecting effect. The combination of laurel and thymol effectively helps to protect against hoof diseases. Vaseline forms a water-repellent and dirt-repellent film which protects the hoof against outside influences.

Contenuto/Content
1000 ml.

art LE00050



art LE00063

Skin-Repair: antisettico, applicato sulle fiaccature, ne facilita la guarigione, forma una pellicola protettiva contro virus, batteri e parassiti, e grazie all'ossido di zinco, forma una barriera contro l'umidità.

Skin-Repair: Antiseptic, dermatologically tested care cream which forms a protective film against viruses, bacteria and parasites. High quality vitamins help the wounds to heal better.

Contenuto/Content
150 ml.



art LE00061

Huf-Teer: catrame spray pronto all'uso. Penetra in profondità nello zoccolo formando una barriera a lunga durata contro l'umidità.

Huf-Teer: Ideal basic care to protect the healthy hoof effectively against thrush, especially after the hoof has been cut. The ready-to-spray alcohol solution is applied to the frog.

Contenuto/Content
100 ml.

art LE00130

Refresh-Gel: gel ad effetto rinfrescante dopo l'attività fisica. Gli oli naturali ed il mentolo contenuti favoriscono il benessere del cavallo in caso di tensione e rigidità muscolare.

Refresh-Gel: The strongly cooling Refresh-Gel has a regenerating effect after physical activity and, on account of the natural oils it contains, promotes the well-being of the horse even in the case of tension and stiff muscles.

Contenuto/Content
500 ml.



art LE00060

Hoof-Oil: olio per zoccoli con lanolina ed olio di alloro, favorisce l'elasticità dello zoccolo e lo rende morbido e resistente. La presenza di timo, ha un effetto calmante sullo zoccolo usurato o danneggiato.

Hoof-Oil: The hoof oil consisting of lanolin and laurel oil promotes elasticity of the hoof horn and makes even soft hooves very resilient again.

Contenuto/Content
500 ml.



art LE00500

Cold-And-Warm-Pack: fasce termoregolabili caldo/freddo. Riscaldabili in acqua, o raffreddabili in freezer sono riutilizzabili più volte.

Cold-And-Warm-Pack: Either warm up the pack in hot water and treat the affected areas or cool it in the freezer for a marvellous cooling effect. Is re-usable and has a long-lasting effect.

Contenuto/Content
2 fasce / 2 pcs.



Ice-Pack: trattamento a freddo in pochi secondi. Riduce il gonfiore ed allevia il dolore in caso di contusioni, stiramenti, distorsioni e punture di insetti. Facile e veloce da utilizzare, ha un'azione di circa 30 minuti. Per un miglior utilizzo, interporre un panno tra l'impacco e la pelle.

Ice-Pack: For cold treatment within seconds. Reduces swelling and soothes pain in the case of bruises, pulled muscles, sprains and insect bites. Particularly safe to transport as the compress is activated by a pulling mechanism and not by exerting pressure. Quick and easy to use everywhere, no pre-cooling necessary. Always put a cloth between a compress and human skin.

Contenuto/Content
1 pacco / 1 pcs

art LE00501



Effol®

244

www.umbriaequitazione.com

Prodotti - Products

White-Star: shampoo spray per cavalli bianchi. La formulazione di alta qualità rimuove anche lo sporco più ostinato e neutralizza gli aloni di colore giallo, per un manto luminoso. Contiene estratti di camomilla per una funzione protettiva della pelle e pantenolo per un pelo lucido e liscio.

White-Star: is the most user-friendly shampoo to spray on your horse, specially designed for greys and other light colours. The high-quality formula also removes stubborn dirt and special additives neutralise the yellow tint - for a gleaming clean and bright coat.

Contenuto/Content
750 ml.

art. LE00112A



Horse-Shampoo: shampoo concentrato ad effetto rinfrescante e rivitalizzante, non ha un effetto sgrassante così da preservare lo strato di protezione naturale della pelle per un effetto setoso. 1 litro di concentrato produce 40 litri di shampoo.

Horse-Shampoo: The care shampoo with human-cosmetic raw ingredients cleans mildly as well as thoroughly. It has a refreshing and vitalising effect, does not have a degreasing effect so that the skin's natural protection layer is preserved.

1 lt. concentrate produces 40 lt.

Contenuto/Content
5000 ml.

art. LE00111



art. LE00121

Hoof-Brush: spazzola per zoccoli in legno di faggio con setole leggermente inclinate per evitare danni alla zona della corona.

Hoof-Brush: The extra long beech wood handle protects against hand injuries when cleaning the hooves.

Contenuto/Content
1 pezzo / 1 pc.

art. LE00090

Grooma Comb: pettine con denti rotanti per facilitare lo spazzolamento.

Grooma Comb: comb with rotating teeth for easy brushing.

Contenuto/Content
1 pezzo / 1 pc.

art. LE00110

Horse-Shampoo: shampoo concentrato ad effetto rinfrescante e rivitalizzante, non ha un effetto sgrassante così da preservare lo strato di protezione naturale della pelle per un effetto setoso. 1 litro di concentrato produce 40 litri di shampoo.

Horse-Shampoo: The care shampoo with human-cosmetic raw ingredients cleans mildly as well as thoroughly. It has a refreshing and vitalising effect, does not have a degreasing effect so that the skin's natural protection layer is preserved. 1 lt. concentrate produces 40 lt. shampoo.

Contenuto/Content
500 ml.

art. LE00122

Orca: spazzola ergonomica per rimuovere facilmente l'acqua in eccesso dopo aver lavato il cavallo.

Orca: Use the Effol Orca to remove surplus water effortlessly after washing your horse.

Contenuto/Content
1 pezzo / 1 pc.

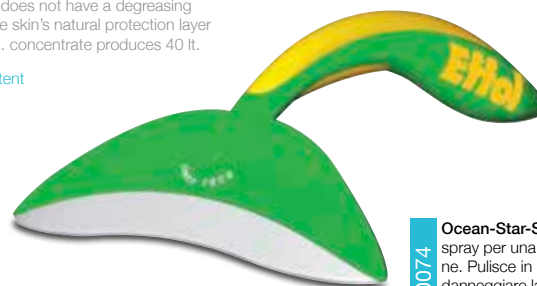

art. LE00120

Shampoo-Brush: spazzola con serbatoio per una pulizia completa e senza spreco di grosse quantità di shampoo. Shampoo-Brush: Simple assistance for rubbing in and lathering shampoo as well as silent application of liquids, thus also suitable for sensitive horses.

Contenuto/Content
1 pezzo / 1 pc.



art. LE00102

Kids-Elastic: elastici colorati per criniera. La confezione contiene colori misti, in maniera da poter creare più fantasie.

Kids-Elastic: The colourful Effol Kids Non-snap Plaiting Bands are made of a special, elastic material.

Contenuto/Content
400 pz / 400 pcs



art. LE00077

Super-Clean: shampoo alla fragranza di albicocca. Igienizza e crea un effetto di lucentezza in tutto il manto.

Super-Clean: is a shampoo with the special scent of apricots and which not only cleans, it also has a caring effect.

Contenuto/Content
300 ml.



art. LE00076

Star-Shine: glitter-spray a lunga durata per cavalli. Applicabile su manto, coda e criniera, contiene glitter argentati ed è profumato al gusto di albicocca.

Star-Shine: is a particularly long-lasting glitter-spray for horses. It can be applied to the coat, mane and tail.

Contenuto/Content
300 ml.



art. LE00073

Dragon-Filmpflaster: cerotto spray trasparente. La formula si basa sul lattice naturale, fornisce una pellicola traspirante che protegge la ferita contro germi e sporco.

Dragon-Filmpflaster: The innovative formula provides an external breathable hygienic film which protects the wound against environmental germs such as dirt, urine and sweat.

Contenuto/Content
200 ml.



art. LE00074

Ocean-Star-Spray: shampoo spray per una facile applicazione. Pulisce in profondità senza danneggiare la pellicola protettiva della pelle. Adatta a tutti i colori di manto, contiene estratti di perle per donare una lucentezza unica.

Ocean-Star-Spray: shampoo spray per una facile applicaThe unique horse and pony shampoo with the practical spray function is much easier to apply than conventional products. It cleans deep into the pores of the horse's coat without damaging the skin's protective film.

Contenuto/Content
750 ml.



art. LE00101

Kids-Elastic: elastici per criniera. Kids-Elastic: Non-snap Plaiting Bands Colori/Colors Trasparente o nero / transparent or black

Contenuto/Content
400 pz / 400 pcs



Umbria equitazione srl Official



Fiebing's

Horse & Leather Care Products



Umbria
equitazione srl
Official

art FB00061

Smacchiatore per cavalli bianchi: Smacchiatore contenente ingredienti naturali, tra cui saponi non irritanti e Tea Tree Oil per pulire in modo efficace coda e criniera del cavallo. Utilizzare Clean Green per eliminare facilmente le macchie di urina, macchie d'erba e le macchie di letame. Rimuove anche le macchie di sudore umido e secco.
Stain remover for white horse: Fiebing's Green Clean spot and stain remover contains natural ingredients including non-irritating soaps and Tea Tree Oil to effectively clean and condition your horse's hair. Use Fiebing's Green Clean to quickly and easily get rid of urine stains, grass stains and manure stains. It also removes wet and dry sweat stains.
Contenuto/Content 946 mL / 32 FL.OZ.
Confezione/Package 6 pz. / 6 Pcs.



art FB00060

Lozione lucidante sgruvigliante: Mantiene criniere e code senza grovigli. Produce una lucentezza sana e un mantello morbido che respinge lo sporco e la polvere. Atossico, sicuro per cavalli sensibili.
Polishing and detangling lotion: Keeps manes and tails tangle free. Produces a healthy sheen and soft coat that repels dirt and dust. Nontoxic safe for use on sensitive horses. More effective yet less expensive than competing conditioners and detanglers.
Contenuto/Content 946 mL / 32 FL.OZ.
Confezione/Package 6 pz. / 6 Pcs.

art FB00190

Shampoo: Ricco, concentrato, pulisce bene e delicatamente il pelo. Contiene due condizionatori e Aloe per la cura della pelle.
Shampoo: The closest thing to taking your horse to the salon! Horse Salon's rich, concentrated formulation cleanses hair thoroughly yet gently, drenching the hair with a luxurious easy to rinse lather removing residual buildup of flysprays, detanglers, environmental pollutants, and hard water minerals. Horse Salon contains two coat conditioners and Aloe as a skin conditioner.
Contenuto/Content 946 mL / 32 FL.OZ.
Confezione/Package 6 pz. / 6 Pcs.



art FB00191

Shampoo per cavalli bianchi: formulato per pulire e regolare manti bianchi. Contiene speciali agenti brillantanti per sbiancare e illuminare durante la rimozione delle urine e delle macchie d'erba. Blue frost deterge il manto delicatamente lasciando il pelo morbido e gestibile.
Shampoo for white horses: Fiebing's Blue Frost is formulated to clean and condition white coats. Contains special brightening agents will whiten and brighten while removing tough urine and grass stains. Blue Frost cleanses the hair thoroughly yet gently leaving hair soft and manageable.
Contenuto/Content 473 mL / 16 FL.OZ.
Confezione/Package 12 pz. / 12 Pcs.

art FB00060

Lucidante zoccolo: A base d'acqua, non tossico per la lucidatura dello zoccolo. Cassetta di sicurezza sia per il cavallo e cavaliere. Svanisce naturalmente, senza prodotti chimici necessari per la rimozione. Confezionato con un cappuccio dauber per una facile applicazione.

Hoof Polish: A water based, nontoxic polish for that super show shine. Safe for both horse and rider. Wears off naturally, no harsh chemicals needed for removal. Packaged with a dauber cap for easy application.
Contenuto/Content 236 mL / 8 FL.OZ.



art FB00100

Olio per zoccoli: Ottimo per l'uso su calli, crepe, zoccoli tagliati e zone fragili. Usato regolarmente aiuta anche a mantenere gli zoccoli sani. Migliora anche l'aspetto dello zoccolo, imprimendo una finitura semilucida.
Hoof oil: Fiebing's Hoof Dressing is today the professional horseman's standard for use on corns, quarter cracks, split hoofs and brittleness. Used regularly it also helps maintain healthy feet. Also improves hoof appearance, imparting a semi-gloss finish.
Contenuto/Content 946 mL / 32 FL.OZ.
Confezione/Package 6 pz. / 6 pcs.



Mantenimento dello zoccolo: una miscela unica di ingredienti speciali per l'uso su zoccoli tagliati, calli, crepe, zoccoli fragili e mantiene la flessibilità dello stesso. Pulire delicatamente gli zoccoli del vostro cavallo prima di applicare Hoof lotion.
Hoof maintenance: A unique blend of special ingredients for use on split hoofs, corns, quarter cracks and brittle feet. Hoof Lotion helps to maintain the pliability of your horse's hoofs. Fiebing's Hoof Lotion with the brush top applicator now includes a built in hoof pick to gently clean your horse's feet prior to applying Hoof Lotion.
Contenuto/Content 946 mL / 32 FL.OZ.
Confezione/Package 6 pz. / 6 Pcs.

art FB00110

Ricrescita del pelo: Lenitivo di pronto soccorso per piccoli tagli, contusioni e ustioni. Cremoso e facile da applicare.
Hair growth: Brings soothing firstaid protection for minor cuts, bruises and burns. Creamy and easy to apply. A must for any stable.
Contenuto/Content 236 Gr. / 8 FL.OZ.
Confezione/Package 12 pz. / 12 Pcs.



Fiebing's

leather
care

Horse & Leather Care Products

246

www.fiebings.com

Prodotti - Products



Sapone liquido: Più comodo da usare rispetto al sapone in barre. Basta spruzzare e strofinare questa miscela pronta all'uso per vedere i risultati. Pulisce e conserva la pelle donando una finitura satinata.
Liquid Soap: More convenient to use than bars. Just spray on and wipe off this ready to use mixture and see the results. Cleans and preserves smooth leather. Buffs to a rich, satin finish.
Contenuto/Content: 473 mL / 16 FL.OZ.
Confezione/Package: 12 pz. / 12 Pcs.



Olio per cuoio: Un conservante naturale al 100% per gli articoli in pelle sottoposti ad uso robusto e l'esposizione all'aperto. Poiché la funzione primaria di un olio per zoccoli è sostituire gli oli evaporati, sostituirli con altri oli naturali è la cosa migliore. Utilizzato da sellai per oltre un secolo.
Leather oil: A 100% natural preservative for leather articles subjected to rugged use and outdoor exposure. Since the primary function of a neatsfoot oil is to replace the evaporated oils in leather, replacing the oils with other natural oils is best. Used by saddle makers for over a century.
Contenuto/Content: 946 mL / 32 FL.OZ.
Confezione/Package: 6 pz. / 6 Pcs.

art FB00021



art FB00122

Sapone liquido: Più comodo da usare rispetto al sapone in barre. Basta spruzzare e strofinare questa miscela pronta all'uso per vedere i risultati. Pulisce e conserva la pelle donando una finitura satinata.
Liquid Soap: More convenient to use than bars. Just spray on and wipe off this ready to use mixture and see the results. Cleans and preserves smooth leather. Buffs to a rich, satin finish.
Contenuto/Content: 946 mL / 32 FL.OZ.
Confezione/Package: 12 pz. / 12 Pcs.

Olio per cuoio: Questa combinazione di oli essenziali per pelle è utilizzato dai produttori di selle in avio per ammorbidire, conservare e impermeabilizzare la pelle. Lubrifica le fibre che ripristinano l'elasticità alla pelle.
Compound Leather oil: essential leather oils is used by saddle and boot makers to soften, preserve and waterproof smooth leather. It lubricates the fibers which restores suppleness to the leather.
Contenuto/Content: 946 mL / 32 FL.OZ.
Confezione/Package: 6 pz. / 6 Pcs.

art FB00170

Grasso per cuoio: Un vero aiuto per selle e finimenti sia in climi freddi e asciutti che caldi e umidi. Contiene cera d'api naturale. Perfetto per l'uso su selle, finimenti e stivali.
Leather conditioner: Aussie Leather Conditioner helps leather to withstand hot, dry climate conditions. Contains natural beeswax. A must for saddle owners in bitter cold, dry areas as well as those in hot, dry climates. Perfect for use on saddles, tack and boots.
Contenuto/Content: 400 Gr. / 15 FL.OZ.
Confezione/Package: 6 pz. / 6 Pcs.



Sapone in barra: La barra di glicerina 100% ripristina la pelle con una finitura satinata. Un pulitore eccellente e conservante.
Bar Soap: The 100% glycerine bar restores leather to its full-bodied suppleness and buffs to a rich, satin finish. An excellent cleaner and preservative.
Contenuto/Content: 198 Gr. / 7 FL.OZ.
Confezione/Package: 12 pz. / 12 Pcs.

art FB00040



Sapone in pasta: Utilizzato in tutto il mondo per selleria, stivali, scarpe e altri articoli in pelle. Pulisce la pelle e lubrifica le fibre per prevenire fragilità, pur mantenendo morbidezza e resistenza. Formulato in giallo, bianco e nero.
Paste Soap: Used in over the world on fine saddlery, boots, shoes and other smooth leather articles. Cleans leather and lubricates the fibers to prevent brittleness, all the while maintaining suppleness and strength. Formulated in yellow, white and black.
Contenuto/Content: 340 Gr. / 12 FL.OZ.
Confezione/Package: 12 pz. / 12 Pcs.

art FB00121





Umbria
equitazione srl
Official

Vigorsal: mangime minerale complementare in rullo grigio.
Vigorsal:
Salt Lick in grey.
Contenuto/Content
700 gr.
Confezione/Package
25 pz. / 25 pcs.

art. VA00140G



Vigorsal: mangime minerale complementare in rullo rosso.
Vigorsal:
Salt Lick in red.
Contenuto/Content
700 gr.
Confezione/Package
25 pz. / 25 pcs.

art. VA00140



SIVAM

Fosfobloc 6,5: mangime minerale complementare in blocchi.
Fosfobloc 6,5:
Salt Lick in block.
Contenuto/Content
5 Kg.
Confezione/Package
2 pezzi / 2 pcs.

art. VA00145

Equisal: mangime minerale complementare in rullo.
Equisal:
Salt Lick in green.
Contenuto/Content
700 gr.
Confezione/Package
20 pz. / 20 pcs.

art. VA00138



SIVAM

SIVAM



art. VA00141

Portasale: portasale per sali a rullo. Ideale per i sali art. VA00138, VA00140, VA00140G.
Portasale: salt lick holder. Ideal for art. VA00138, VA00140, VA00140G.
Confezione/Package
5 pezzi / 5 pcs.

art. VA00142

Portasale: portasale a mattonella in ferro. Ideale per il sale a mattonella Rockie (VA00139).
Portasale: salt lick holder. Ideal for Rockie salt (VA00139).



Rockie: mangime minerale complementare a mattonella.
Rockie: salt lick in red
Contenuto/Content
2 Kg.
Confezione/Package
10 pz. / 10 pcs.

art. VA00139



Himalaya: sale rosa dell'Himalaya. Il sale rosa, non è raffinato, viene estratto, lavato in soluzione satura ed impacchettato. Velocemente assimilabile, non ha aggiunta di componenti chimici.
Himalaya: Natural salt lick from the Himalaya. The pink salt is not refined, is extracted, washed and wrapped in a saturated solution. Quickly assimilated, not addition of chemicals components.
Contenuto/Content
5 Kg.
Confezione/Package
2 pezzi / 2 pcs.

art. VA00140C

Himalaya: sale rosa dell'Himalaya. Il sale rosa, non è raffinato, viene estratto, lavato in soluzione satura ed impacchettato. Velocemente assimilabile, non ha aggiunta di componenti chimici.
Himalaya: Natural salt lick from the Himalaya. The pink salt is not refined, is extracted, washed and wrapped in a saturated solution. Quickly assimilated, not addition of chemicals components.
Contenuto/Content
2,5/3 Kg.
Confezione/Package
6 pezzi / 6 pcs.

art. VA00140B



Himalaya: sale rosa dell'Himalaya. Il sale rosa, non è raffinato, viene estratto, lavato in soluzione satura ed impacchettato. Velocemente assimilabile, non ha aggiunta di componenti chimici.
Himalaya: Natural salt lick from the Himalaya. The pink salt is not refined, is extracted, washed and wrapped in a saturated solution. Quickly assimilated, not addition of chemicals components.
Contenuto/Content
1,5 Kg.
Confezione/Package
10 pezzi / 10 pcs.

art. VA00140A



www.umbriaequitazione.com



Umbria
equitazione srl
Official

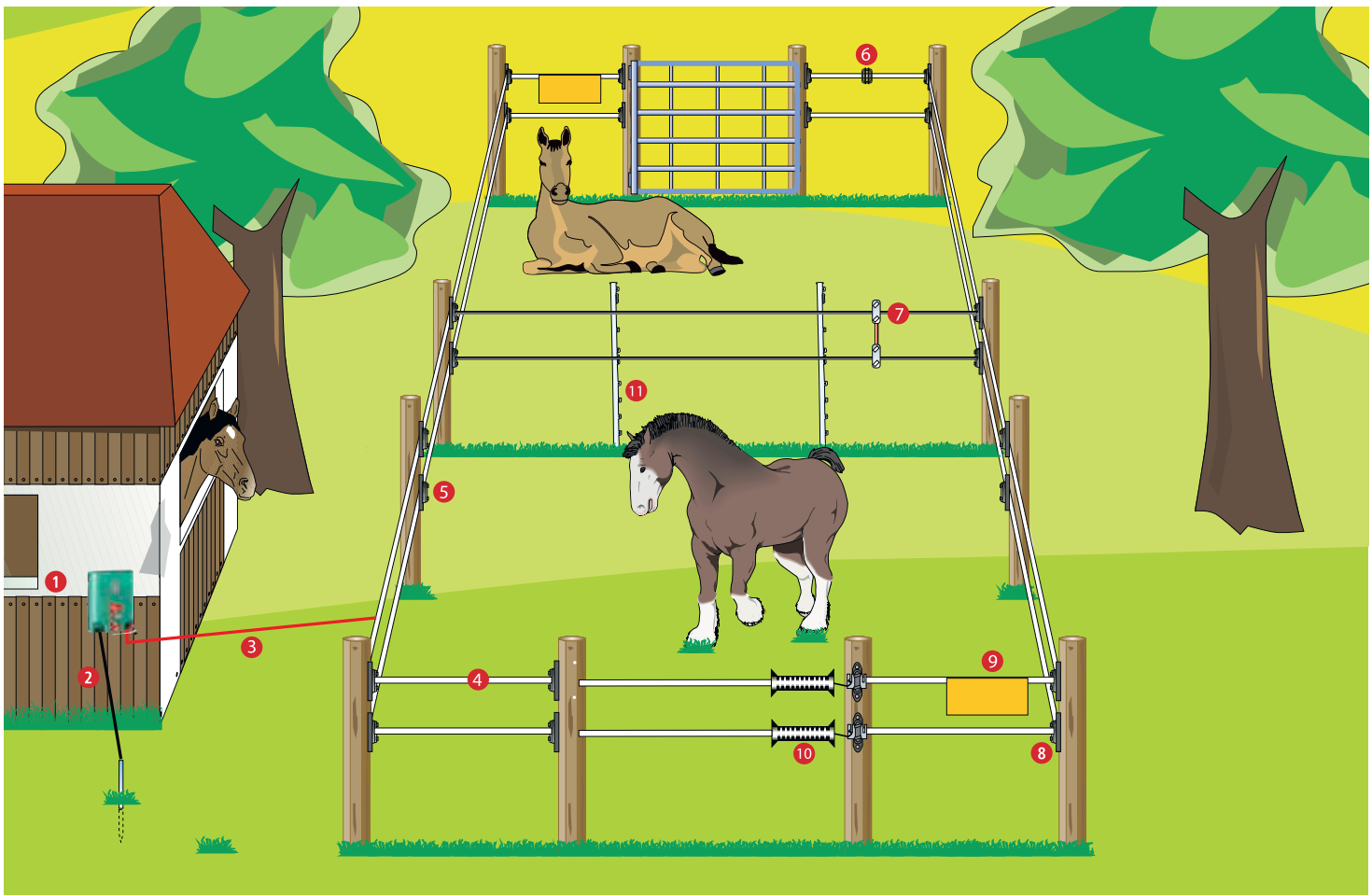

www.umbriaequitazione.com

249

Recinzioni Elettriche - Electric Fences

Alimentatori a batteria o corrente
pag. 250-53
Electric fence unit for mains or battery
operation pag. 250-53



1

Cavo messa a terra pag. 258
Earthing cable pag. 258



2

Cavo di connessione al recinto
pag. 258
Connection Cable Heart-shaped Clip
pag. 258



3

Filo, fettuccia o corda elettrificata
pag. 254-55
Fence tape, rope, polywire or wire
pag. 254-55



4

Isolatori per filo, corda e fettuccia
pag. 259-61
Stretch insulator
pag. 259-61



5

Picchetti per recinti con isolatori
pag. 257
Portable fencing posts
pag. 257



11

Giunzioni per filo, corda e fettuccia
pag. 256
Special connector for conductive
materials pag. 256



6

Cavi di collegamento per filo, corda e
fettuccia pag. 258
Tape, rope, wire connecting cable
pag. 258



7

Isolatori angolari per filo, corda e
fettuccia pag. 261
Corner insulator
pag. 261



8

Targhe di segnalazione per recinti
elettrici pag. 257
Warning sign
pag. 257



9

Maniglie e cancelli per recinti elettrici
pag. 258-59
Gate Handles and Gate kit
pag. 258-59



10



Per consentire all' elettricità di circolare liberamente da terra al dispositivo, deve essere assicurato un contatto ottimale tra l' asta di terra e il suolo (il terreno asciutto è un cattivo conduttore di elettricità). L' asta di messa a terra (che deve essere zincata) deve essere collocata su una superficie umida e la lunghezza dell' asta di terra deve essere misurata per garantire uno scarico a terra ottimale. Il numero consigliato di bare di messa a terra dipende dalla classe di potenza del dispositivo.



In order to enable electricity to flow freely from the ground to the device, optimal contact should be ensured between the earthing rod and soil (dry soil is a poor electricity conductor). The earthing rod (which must be galvanised) should therefore be driven into a damp area, or the length of the earthing rod should be measured to ensure that deeper, damper soil layers are reached. The recommended number of earthing rods depends on the power class of the device.



Ca. Numero di reti elettrificabili: per dispositivi 230V e 12V, su 50 metri di rete, viene fornito il numero massimo di linee da utilizzare.
Approx. Number of Electrifiable Nets: For 230 V and 12 V devices, the maximum number of 50 m lines to be used is given.



La flora ha una notevole influenza sulla max. lunghezza che un erogatore elettrico riesce a raggiungere sulla recinzione. Più vegetazione comporta più carica accumulata sul recinto, diminuendone così la portata. Le indicazioni sulla lunghezza della recinzione si riferiscono a materiale (filo e connettori) con ottima conduzione, buoni isolatori e di un sistema di messa a terra ottimale!
Flora on the fence has a considerable influence on the max. fence length for an electric fence device. The more vegetation on the fence, the higher the fence charge will be, thus reducing the max. fence length. The fence length indicators refer to highly conductive wire material and connectors, good isolators and an optimal earthing system!



Max. Uscita: energia massima trasmessa dal dispositivo al sistema di recinzione. Questo impulso è anche identificato come forza d'urto.
Max. Output: Maximum energy transmitted from the device to the fence system. This pulse is also identified as shock strength.



Consumo: La durata di un dispositivo schermatore elettrico può essere calcolata dal consumo di energia con la batteria o dalla capacità dell' accumulatore.
Power Consumption: The duration of an electric fence device can be calculated from the power consumption along with battery or accumulator capacity.



Portata teorica in lunghezza del recinto VDE (2000 V): vengono espressi solo dati teorici, che, a seguito di varie influenze (flora sulla recinzione, condizioni climatiche e del suolo) non possono essere precisi nella pratica.
Theor. Fence Length VDE (2000 V): Concerning fence systems in accordance with VDE, only theoretical values are given, which, as a result of various influences (fence flora, weather and soil conditions) cannot be reached in practice.



Max. Voltaggio: Questa tensione viene raggiunta con una carica bassa sulla recinzione.
Max. Voltage: This voltage is reached with a low fence charge.



Resistenza: resistenza del materiale conduttivo visualizzato in Ohm / m. Minore è il valore, migliore è la conducibilità del materiale.
Resistance: Conductive material resistance displayed in Ohm/metres. The smaller this value, the better the material's conductivity.



Energia immagazzinata: energia assorbita dal dispositivo. L' indice di efficienza elettrica produce il valore energetico rilevabile per l' utente.
Stored Energy: Energy absorbed by device. The electric fence efficiency ratio yields the relevant discharge energy value for the user.

art EL00203



Corral Super B 170

- dispositivo con alimentazione a batteria 9V/12V e corrente 230V (trasformatore incluso nella confezione). Carica corrente in joule 0,25.
- due livelli di rendimento
- controllo ottico della batteria
- alloggiamento resistente alle intemperie
- prodotto in Germania
- 3 anni di garanzia

Corral Super B 170

- device with battery power supply 9V/12V and 230V (transformer included). Load current in joules 0.25
- two levels of performance
- optical control of the battery
- weatherproof housing
- made in Germany
- 3 years warranty

Batteria non inclusa / Battery not included



9V
12V



230V

art EL00210



Corral Super B 340

- dispositivo con alimentazione a batteria 9V/12V e corrente 230V (trasformatore incluso nella confezione) per recinti di media lunghezza. Carica corrente in joule 0,54.
- due livelli di rendimento
- controllo ottico della batteria
- alloggiamento resistente alle intemperie
- prodotto in Germania
- 3 anni di garanzia

Corral Super B 340

- device with battery power supply 9V/12V and 230V (transformer included) for medium length fencing. Load current 0.54 joules.
- two levels of performance
- optical control of the battery
- weatherproof housing
- made in Germany
- 3 years warranty

Batteria non inclusa / Battery not included



9V
12V



230V

Modello Model	Codice Code											
B170/9V	EL00203	9.400 V	2.600 V	0,25 J	0,17 J	13-19 mA	7,0 km	3,0 km	1,0 km	0,3 km		1
B170/12V	EL00203	10.000 V	3.000 V	0,27 J	0,22 J	12-18 mA	8,0 km	4,0 km	1,5 km	0,4 km		1
B340/9V	EL00210	9.600 V	3.100 V	0,54 J	0,34 J	24-36 mA	12,0 km	4,0 km	2,0 km	0,5 km		1
B340/12V	EL00210	10.500 V	3.500 V	0,60 J	0,42 J	22-34 mA	14,0 km	5,0 km	2,5 km	0,6 km		1

art EL00220



Corral Super N 3500

- alimentatore a scossa molto forte
- adatto ad aree con poca o media vegetazione
- controllo ottico della tensione recinto e del collegamento a terra (i guasti vengono indicati da lampeggi di colore rosso)
- consumo di energia 7 watts
- prodotto in Germania
- 3 anni di garanzia

Corral Super N 3500

- Highly efficient all-round power supply unit
- can be used with light to medium vegetative growth
- Visual fence voltage display and earthing display (a flashing red light indicates a fault)
- power consumption 7.0 watts
- made in Germany
- 3 years warranty



230V

art EL00230



Corral Super N 1700

- alimentatore a scossa forte
- due uscite (scossa forte/scossa bassa)
- luci di controllo delle operazioni
- consumo di energia 5 watts
- prodotto in Germania
- 3 anni di garanzia

Corral Super N 1700

- Efficient power supply unit
- for universal use with standard fences
- Indicator light
- power consumption 7.0 watts
- made in Germany
- 3 years warranty



230V

Modello Model	Codice Code											
N1700	EL00230	10.200 V	4.200 V	3,50 J	1,70 J	70,0 km	17,0 km	5,5 km	2,2 km	5	2	-
N3500	EL00220	11.000 V	5.400 V	5,50 J	3,50 J	80,0 km	20,0 km	6,0 km	2,5 km	9	3	1

Corral Sun Power S1

- recinto efficiente e poco costoso
- ideale per recinti fino a 2 Km circa di cavo e con poca vegetazione
- ideale per cavalli e altri tipi di bestiame al pascolo
- adatto anche per piccoli animali come cani

la confezione include:

- batteria interna a gel 12 V, 7 Ah
- pannello solare 12 V, 2 watt
- cavi di connessione al recinto e alla terra
- trasformatore 230 volt

Corral Sun Power S1

- efficient and inexpensive fence unit
- Ideal for fences up to 2 Km with little vegetation
- ideal for horses and other livestock grazing
- also suitable for small animals such as dogs

the package includes:

- internal battery gel 12 V, 7 Ah
- solar panel 12 V, 2 watts
- connecting cables to the fence and land
- 230 volt transformer



trasformatore 230 volt per ricaricare la batteria o per mantenerla sempre efficiente durante i mesi invernali

230 volt transformer to recharge the battery or to keep it functioning well during the winter months



New!
Sun Power S1



Umbria
equitazione srl
Official

Corral Solar Kit 8W

- l'alternativa ecologica alla batteria a secco da 9 Volt
- soluzione facile ed economica
- da abbinare ai modelli B170 e B340 (pertanto non è possibile l'utilizzo del solo pannello. Il Solar Kit 8W per funzionare ha sempre bisogno del supporto di una centralina)

la confezione include:

- 1 modulo solare 12 Volt, 8 Watt con supporto
- 1 accumulatore gel da 12 Volt, 12 Ah incluso regolatore di carica
- trasformatore 230 volt

Corral Solar Kit 8W

- the eco-friendly alternative to dry battery 9 Volt
- easy and cheap solution
- to match the models B170 and B340 (so it is not possible use of the panel only. The 8W Solar Kit to work is always in need of support a control unit)

the package includes:

- 1 solar module 12 Volt, 8 Watt with stand
- 1 gel accumulator 12 volt, 12 Ah included charge controller
- 230 volt transformer



trasformatore 230 volt per ricaricare la batteria o per mantenerla sempre efficiente durante i mesi invernali

230 volt transformer to recharge the battery or to keep it functioning well during the winter months

Corral
Solar Kit 8W



art EL00010



Centralina Laser 90120

- dispositivo con alimentazione a batteria 9V/12V e corrente 230V
- tensione massima in uscita 7.500V
- tensione a contatto animale 1.600V
- energia massima 0,50 Joule
- doppia alimentazione:
 - batteria a secco 55-90-130Ah **non in dotazione**
 - rete 230V con alimentatore **fornito in dotazione**
 - batteria 12V tipo auto tramite cavetto adattatore **non in dotazione**

Electric fence unit Laser 90120

- fence unit with battery power supply 9V/12V and 230V
- maximum output voltage 7.500V
- voltage contact animal 1.600V
- max. energy 0.50 Joule
- dual power supply:
 - dry battery 55-90-130Ah not supplied
 - 230V with power supply provided
 - 12V car battery type via adapter cable not supplied



9V

12V

230V

MADE IN ITALY

Laser

90120

art EL00013



Centralina Laser 90430

- dispositivo con alimentazione a batteria 9V/12V e corrente 230V
- tensione massima in uscita 10.000V
- tensione a contatto animale 3.200V
- energia massima 0,8 Joule
- doppia alimentazione:
 - batteria a secco 55-90-130Ah **non in dotazione**
 - rete 230V con alimentatore **fornito in dotazione**
 - batteria 12V tipo auto tramite cavetto adattatore **non in dotazione**

Electric fence unit Laser 90430

- fence unit with battery power supply 9V/12V and 230V
- maximum output voltage 10.000V
- voltage contact animal 3.200V
- max. energy 0,8 Joule
- dual power supply:
 - dry battery 55-90-130Ah not supplied
 - 230V with power supply provided
 - 12V car battery type via adapter cable not supplied



9V

12V

230V

MADE IN ITALY

Laser

90430

art EL00011



Centralina Laser 9006

- dispositivo con alimentazione a batteria 12V e corrente 230V
- tensione massima in uscita 6.100V
- tensione a contatto animale 1.600V
- energia massima 0,14 Joule
- doppia alimentazione:
 - rete 230V con alimentatore **fornito in dotazione**
 - batteria 12V tipo auto tramite cavetto adattatore **non in dotazione**

Electric fence unit Laser 9006

- fence unit with battery power supply 9V/12V and 230V
- maximum output voltage 6.100V
- voltage contact animal 1.600V
- max. energy 0,14 Joule
- dual power supply:
 - 230V with power supply provided
 - 12V car battery type via adapter cable not supplied



12V

230V

MADE IN ITALY

Laser

9006

Corral Travel Kits

- kit recinto elettrico portatile da trekking
- assemblaggio e smontaggio facili e veloci
- peso circa 3 Kg

la confezione include:

- 2 batterie da 1,5 Volt
- 1 dispositivo Compact Power B40
- 2 maniglie con 50 metri di banda ognuna
- 4 paletti smontabili da 1,15 metri
- 5 elastici con paletti a terra
- 8 isolatori
- 1 borsa da trasporto

Corral Hobby Kits

- The ideal to fence horses during trekking.
- assembly and disassembly quick and easy
- weight about 3 kg

the package includes:

- 2 x 1.5V dry battery
- 1 fence unit Compact Power B40
- 2 handles with 50 meters of each band
- 4 removable stakes 1.15 meters
- 5 elastics with stakes on the ground
- 8 insulators
- 1 carrying bag



Corral Travel Kit



Umbria
equitazione srl
Official

POWER ENERGY

art EL00030

Power Battery 10.000 h

- 90 ah - 440 Wh - 9 V
- 0% mercurio - cadmio
- completa con cavetti e pronta all'installazione
- non ricaricabile

Power Battery 10.000 h

- 90 ah - 440 Wh - 9 V
- 0% mercury - cadmium
- complete with wires and ready for installation
- non-rechargeable

POWER ENERGY

art EL00040

Power Battery 5.000 h

- 55 ah - 440 Wh - 9 V
- 0% mercurio - cadmio
- completa con cavetti e pronta all'installazione
- non ricaricabile

Power Battery 5.000 h

- 55 ah - 440 Wh - 9 V
- 0% mercury - cadmium
- complete with wires and ready for installation
- non-rechargeable



art EL00060



Filo 250M

- 3 conduttori in acciaio da 0,16 mm
- carico di rottura 60 Kg max.
- resistenza 13.78 Ω / m
- lunghezza raccomandata max. del recinto 150 m

Polywire 250M

- 3 SS conductors 0.16 mm
- breaking load 60 kg max.
- resistance 13.78 Ω / m
- recommended length max. fence 150 m



art EL00061



Filo 500M

- 3 conduttori in acciaio da 0,16 mm
- carico di rottura 60 Kg max.
- resistenza 13.78 Ω / m
- lunghezza raccomandata max. del recinto 150 m

Polywire 500M

- 3 SS conductors 0.16 mm
- breaking load 60 kg max.
- resistance 13.78 Ω / m
- recommended length max. fence 150 m



art EL00080



Banda 2 cm Bianca

- altezza 2 cm
- bobina da 200 metri
- carico di rottura 90 Kg max.
- resistenza 10.8 Ω / m
- 4 conduttori in acciaio da 0,16 mm

Tape 2 cm White

- width 2 cm
- 200m reel
- breaking strength 90 kg max.
- resistance 10.8 Ω / m
- 4 SS conductors 0.16 mm



art EL00080R



Banda 2 cm Rossa

- altezza 2 cm
- bobina da 200 metri
- carico di rottura 90 Kg max.
- resistenza 10.8 Ω / m
- 4 conduttori in acciaio da 0,16 mm

Tape 2 cm Red

- width 2 cm
- 200m reel
- breaking strength 90 kg max.
- resistance 10.8 Ω / m
- 4 SS conductors 0.16 mm



art EL00080A



Banda 2 cm High-Quality Bianca

- altezza 2 cm
- bobina da 200 metri
- carico di rottura 120 Kg max.
- resistenza 2.56 Ω / m
- 4 conduttori in acciaio da 0,20 mm + 2 da 0,30 mm
- lunghezza raccomandata max. del recinto 800 m

Tape 2 cm High-Quality White

- width 2 cm
- 200m reel
- breaking strength 120 kg max.
- resistance 2.56 Ω / m
- 4 SS conductors 0.20 mm + 2 SS 0,30 mm
- recommended length max. fence 800 m



art EL00081A



Banda 4 cm High-Quality Bianca

- altezza 4 cm
- bobina da 200 metri
- carico di rottura 230 Kg max.
- resistenza 1.21 Ω / m
- 9 conduttori da 0,20 mm + 4 da 0,30 mm
- lunghezza max. del recinto 1.600 m

Tape 4 cm High-Quality White

- width 4 cm
- 200m reel
- breaking strength 230 kg max.
- resistance 1.21 Ω / m
- 9 SS conductors 0.20 mm + 4 SS 0,30 mm
- recommended length max. fence 1.600 m



Banda 4 cm High-Quality Verde

- altezza 4 cm
- bobina da 200 metri
- carico di rottura 230 Kg max.
- resistenza 1.21 Ω / m
- 9 conduttori da 0,20 mm + 4 da 0,30 mm
- lunghezza max. del recinto 1.600 m

Tape 4 cm High-Quality Green

- width 4 cm
- 200m reel
- breaking strength 230 kg max.
- resistance 1.21 Ω / m
- 9 SS conductors 0.20 mm + 4 SS 0,30 mm
- recommended length max. fence 1.600 m

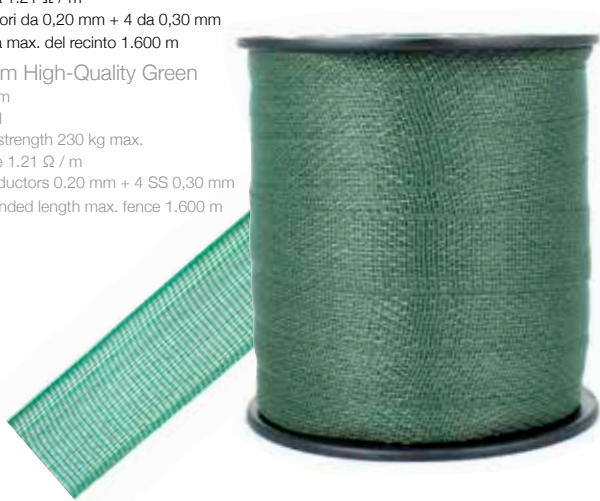

Banda 4 cm Bianca

- altezza 4 cm
- bobina da 200 metri
- carico di rottura 120 Kg max.
- resistenza 5.4 Ω / m
- 8 conduttori da 0,16 mm

Tape 4 cm White

- width 4 cm
- 200m reel
- breaking strength 120 kg max.
- resistance 5.4 Ω / m
- 8 SS conductors 0.16 mm



Banda 4 cm Rossa

- altezza 4 cm
- bobina da 200 metri
- carico di rottura 120 Kg max.
- resistenza 5.4 Ω / m
- 8 conduttori da 0,16 mm

Tape 4 cm Red

- width 4 cm
- 200m reel
- breaking strength 120 kg max.
- resistance 5.4 Ω / m
- 8 SS conductors 0.16 mm



Corda 6 mm Bianca

- diametro 6 mm
- bobina da 200 metri
- carico di rottura 350 Kg max.
- resistenza 3.87 Ω / m
- 6 conduttori da 0,20 mm

Corda Elettrica 6 mm

- diameter 6 mm
- 200m reel
- breaking strength 350 kg max.
- resistance 3.87 Ω / m
- 6 SS conductors 0.20 mm



Corda 6 mm High-Quality Bianco/Rossa

- diametro 6 mm
- bobina da 200 metri
- carico di rottura 350 Kg max.
- resistenza 0.311 Ω / m
- 6 conduttori da 0,30 mm

Rope 6 mm HQ White/Red

- diameter 6 mm
- 200m reel
- breaking strength 350 kg max.
- resistance 0.311 Ω / m
- 6 SS conductors 0.30 mm



Corda EconomyLine 500M

- corpo interno in nylon da 1,4 mm
- bobina da 500 metri
- carico di rottura 45 Kg max.
- resistenza 0.35 Ω /m
- 2 conduttori in acciaio da 0,50 mm

EconomyLine Mono Wire

- nylon core of 1.4 mm
- 500m reel
- breaking strength 45 kg max.
- resistance 0.35 Ω / m
- 2 SS conductors 0.50 mm



art EL00111



Giunzione per fettuccia 1 cm
 • metallo zincato
 Tape Connector 1 cm
 • galvanized

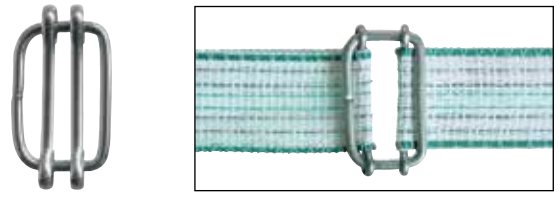

art EL00110



Giunzione per fettuccia 2 cm
 • metallo zincato
 Tape Connector 2 cm
 • galvanized

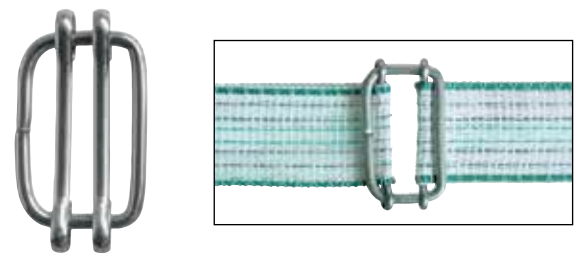

art EL00109



Giunzione per fettuccia 4 cm
 • metallo zincato
 Tape Connector 4 cm
 • galvanized

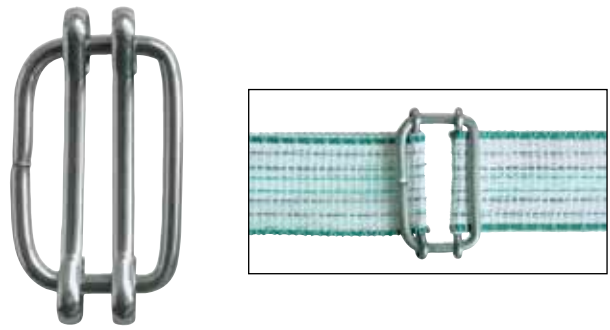

art EL00107



Giunzione per filo e corda 1,4 mm
 • metallo zincato
 Wire - Rope Connector 1,4 mm
 • galvanized

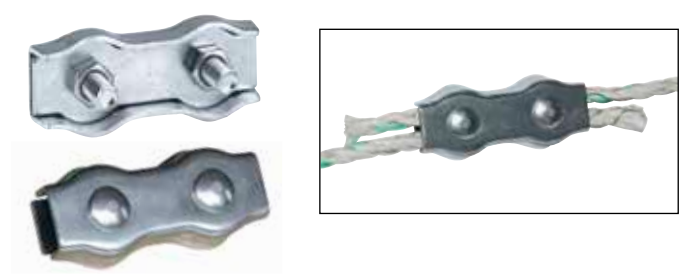

art EL00108



Giunzione per corda 6 mm
 • metallo zincato
 Rope Connector 6 mm
 • galvanized



art EL00113



Giunzione Litzclip 20 mm
 • Metallo zincato
 • Connessione veloce e sicura

Tape Connector Litzclip 20 mm
 • galvanized
 • Fast and safe connection

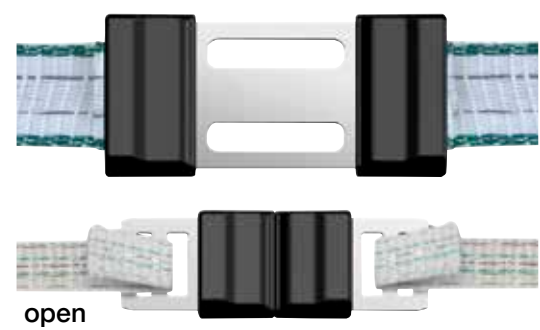

art EL00114



Giunzione Litzclip 40 mm
 • Metallo zincato
 • Connessione veloce e sicura

Tape Connector Litzclip 40 mm
 • galvanized
 • Fast and safe connection

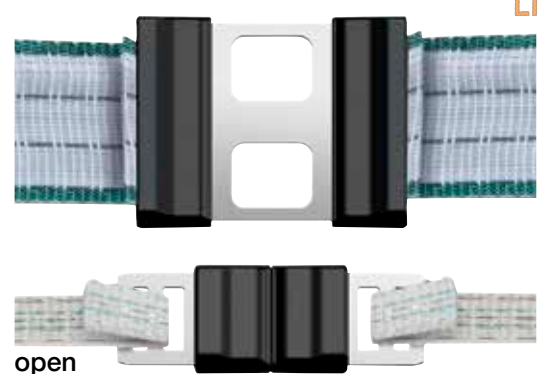

art EL00115



Giunzione Litzclip per corda max. 6 mm
 • Metallo zincato
 • Connessione veloce e sicura

Wire - Rope Connector Litzclip
 • max. 6 mm
 • galvanized
 • Fast and safe connection

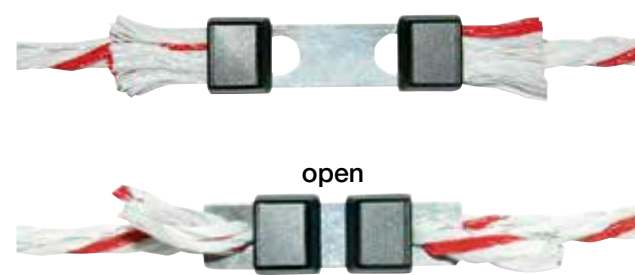

Tester di linea per recinzioni

- misura la tensione in sei livelli
- non sono necessarie batterie

Fence Tester

- shows the voltage in six levels
- no batteries required



Ricevitore di controllo continuità recinto

- permette di controllare la presenza di tensione sulla recinzione camminando ad una distanza di circa 1 metro dal filo.
- Batteria da 9V **non in dotazione**.

Electric fence tester

- allows to check the presence of voltage walking on the fence at a distance of about 1 meter from the wire.
- 9V battery not included.



Tester prova batteria 9V

- Con questo tester è possibile misurare tutte le batterie con tensione nominale di 9V usate negli elettrificatori per recinti elettrici. Prodotto costruito in Italia.

Battery tester 9V

- With this tester you can measure all the batteries with nominal voltage of 9V used in fencing electric units. Product made in Italy.



Trasformatore 230V

- Adattatore 230V per recinti a batteria Corral

Mains adapter 230V

- Mains adapter 230V for fence units

x Corral



Trasformatore 230V

- Adattatore 230V per recinti a batteria Umbria Laser

Mains adapter 230V

- Mains adapter 230V for fence units

x Laser



Targa segnalazione recinto

- Plastica di ottima qualità
- dimensioni 200 x 120 mm
- carico di rottura 45 Kg max.
- stampato su doppio lato

Warning sign electric fence

- made of stable grade plastic
- dimensions: 200 x 120 mm
- breaking load 45 Kg max.
- double-sided printed



Picchetto per recinzioni mobili

- con isolatori incorporati

Portable fencing posts

- with fixed insulators

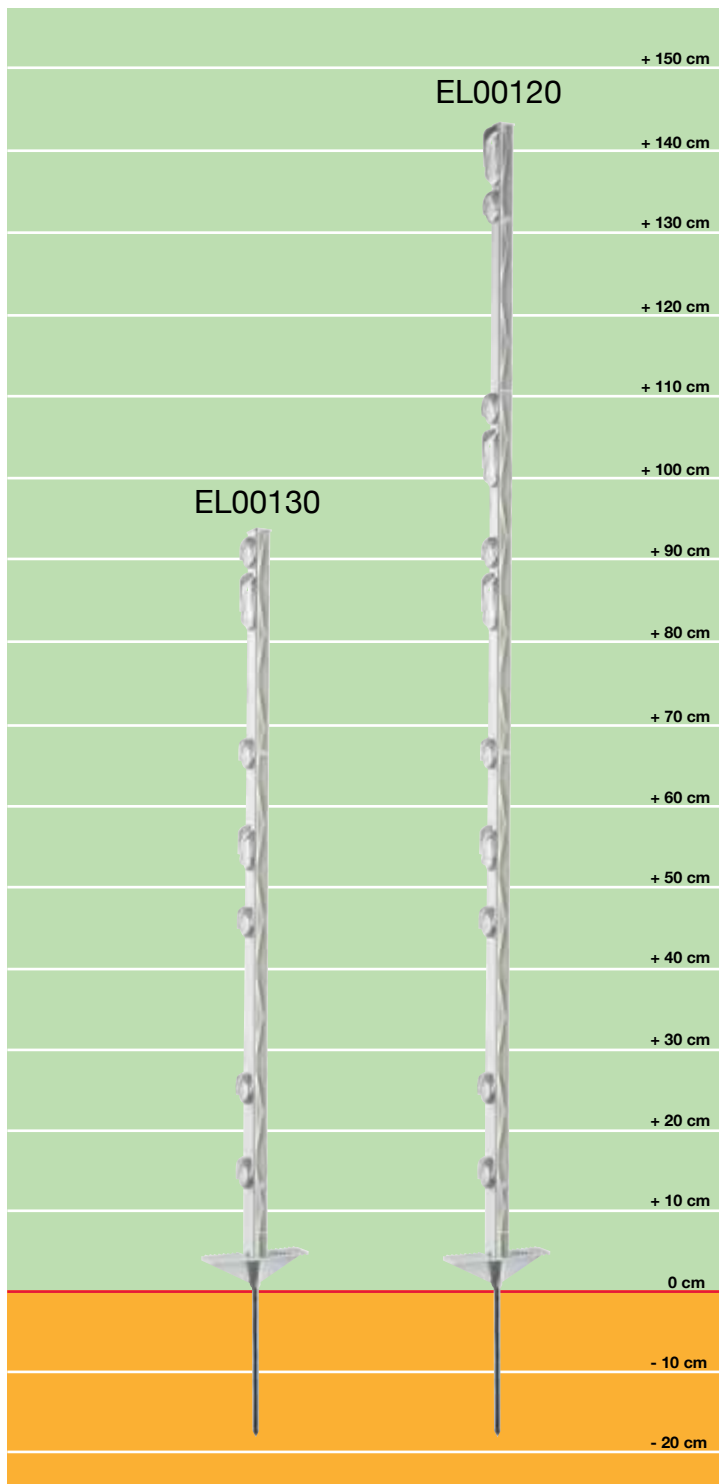

art EL00054 **Umbria**
EQUITAZIONE

- Cavo di connessione recinto**
- connette l'elettrificatore direttamente al recinto
 - lunghezza filo 125 cm
- Connection Cable Heart-shaped Clip**
- connects fencer and wire or polywire
 - lead length 125 cm

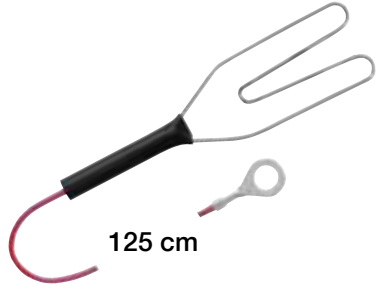

art EL00055 **Umbria**
EQUITAZIONE

- Cavo di messa a terra**
- connette l'elettrificatore alla presa a terra
 - lunghezza filo 100 cm
- Ground Connection Cable**
- connects energizer and ground rod
 - lead length 100 cm



art EL00112 **AKO**

- Cavi per batteria 12V**
- collegano la batteria da 12V a tutti i recinti 9V
 - cavo da 80 cm
- 12 Volt Adapter cable**
- connects 12 Volt wet rechargeable battery
 - for connection to all our 9 V electrical fences
 - with 80 cm cable



art EL00105 **AKO**

- Cavo di connessione doppio**
- lunghezza 60 cm
 - completo con morsetti a coccodrillo
- Fence Connection Cable**
- lead length 60 cm
 - with 2 heavy-duty crocodile clips

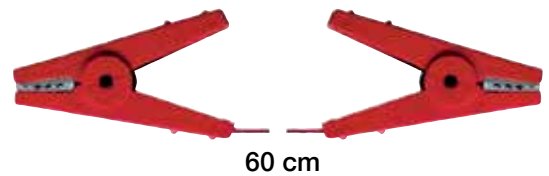
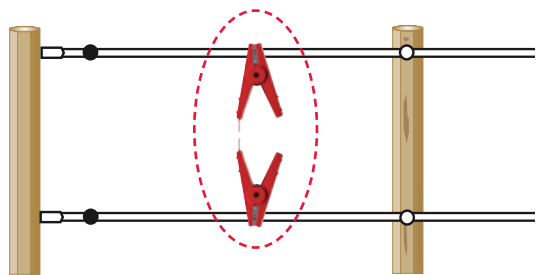

art EL00106 **AKO**

- Cavo di connessione triplo**
- lunghezza 2x60 cm
 - completo con morsetti a coccodrillo
- Fence Connection Cable, triple**
- lead length 2x60 cm
 - with 3 robust crocodile clips

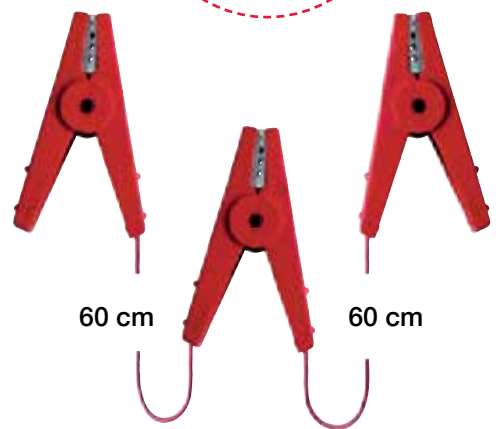
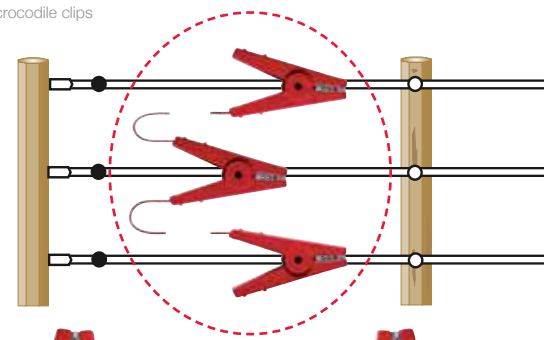

art EL00052 + EL00052A **POWER ENERGY**

- Maniglia isolante**
- con molla interna
 - disponibile in 2 colori: nera (EL00052) gialla (EL00052A)
- Gate Handle**
- with tension limiter
 - available in 2 colors: black (EL00052) yellow (EL00052A)

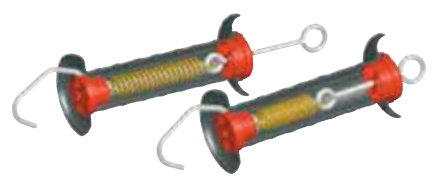

art EL00051 **POWER ENERGY**

- Kit maniglia con molla**
- allungabile fino a 5 metri
 - composto da maniglia, molla e 2 isolatori
- Gate Kit**
- stretches up to about 5 m
 - 1x gate handle
 - 1x spring
 - 2x gate insulators



Molla di ricambio
 • allungabile fino a 5 metri
 Replacement spring
 • stretches up to about 5 m



Isolatore per cancello
 • girevole a 360° con vite a legno
 Gate Handle Insulator
 • hooks in gate handles from both sides, 360° swivel loop



Umbria
equitazione srl
Official

www.umbriaequitazione.com

Isolatore per corda
 • con vite a legno
 • colore nero
 • confezione da 50 pezzi
 Ring Insulator
 • wood wire
 • black
 • package 50 pcs



Isolatore per corda
 • con vite a legno
 • colore giallo
 • confezione da 50 pezzi
 Ring Insulator
 • wood wire
 • yellow
 • package 50 pcs



Kit isolatori+supporto per avvitatore
 • 100 pz. isolatori con vite a legno colore nero
 • 1 pz. supporto per avvitatore
 • comoda confezione in plastica con tappo.
 Ring Insulators with short support
 • 100 pz. ring insulators
 • with short 6 mm support and new self-cutting thread
 • easy packaging with plastic cap.



Supporto per avvitatore
 • in plastica ultra-resistente con aggancio in metallo
 • facile da usare
 Short support
 • with short 6 mm support and new self-cutting thread
 • easy to use

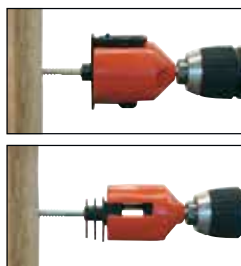

100 x



1 x



art EL00036



Isolatore per corda

- con vite a legno
- colore nero
- confezione da 50 pz.

Wire / Rope Insulator

- wood wire
- black
- packing 50 pcs.



art EL00059



Isolatore distanziato per corda

- con vite a legno
- colore nero
- confezione da 10 pz.

Wire / Rope Offset Insulator

- wood wire
- black
- packing 10 pcs.



art EL00046



Isolatore per corda

- colore nero
- confezione da 25 pz.

Wire / Rope Insulator

- black
- packing 25 pcs.



art EL00046A



Adattatore a morsa

- per paletti tondi da 35 - 70 mm
- protezione in gomma inclusa
- per EL00046 (isolatore non incluso)

Fastening Ring for Round Posts

- for 35 - 70 mm round posts
- incl. rubber inlay to protect the posts
- for EL00046 (insulator not included)



art EL00047



Isolatore per corda Isobloc

- adatto per picchetti in ferro max 14 mm
- chiusura con vite di sicurezza
- confezione da 25 pz

Wire / Rope Insulator Isobloc

- for stakes max 14 mm
- closure with safety screw
- packing 25 pcs.



Isobloc

art EL00047A



Isolatore per banda Irubloc

- adatto per picchetti in ferro max 14 mm
- chiusura con vite di sicurezza
- confezione da 25 pz

Tape Insulator Irubloc

- for stakes max 14 mm
- closure with safety screw
- packing 25 pcs.



Irubloc

art EL00043



Isolatore per banda Vario Plus

- adatto per picchetti in ferro max 17 mm
- chiusura con vite di sicurezza
- confezione da 10 pz

Tape insulator Vario Plus

- for stakes max 17 mm
- closure with safety screw
- packing 10 pcs.



art EL00045



Isolatore per banda

- con vite a legno
- chiusura a scatto
- confezione da 50 pz.

Tape Insulator

- wood wire
- black
- packing 50 pcs.



Isolatore Pro Fence

- per bande fino a 4 cm e corde fino a 6 mm
- chiusura con clip
- Confezione da 25 pz

Pro Fence Insulator

- for tapes up to 40 mm and ropes up to 6 mm
- clip closure
- packing 25 pcs.



Isolatore Pro Fence plus

- adatto per picchetti in ferro max 14 mm
- per bande fino a 4 cm e corde fino a 6 mm
- Confezione da 25 pz

Pro Fence plus Insulator

- for stakes max 14 mm
- for tapes up to 40 mm and ropes up to 6 mm
- packing 25 pcs.



Isolatore per banda Fix

- per banda max. 40 mm
- chiusura con clip
- Confezione da 25 pz

Fix Tape Insulator

- for tapes up to 40 mm
- clip closure
- packing 25 pcs.



Isolatore angolare

- per corda e filo
- girevole
- Confezione da 10 pz

Corner Insulator

- for wire and rope
- swivel insulator
- packing 10 pcs.



Isolatore angolare

- antiscivolo, con gommino interno
- ottimo se usato sugli angoli
- Confezione da 10 pz

Corner and Distance Insulator

- anti-slip by alternating rubber pad structure
- end or strain insulator, also excellent for corners
- packing 10 pcs.



Isolatore angolare

- adatto a qualsiasi tipo di recinto
 - robusto e girevole
 - Confezione da 2 pz
- Corner Insulators with Buckles**
- easy to hang in gate handles
 - forks off in different directions
 - Confezione da 2 pcs.



Avvolgitore per banda Premium

- Pratico e veloce, si applica come un semplice isolatore
- per banda max 40 mm

Premium Tape Tensioner

- simple, secure tensioning by hand without tools - notch function
- for broad-bands of up to 40 mm



**Premium
TAPE**



Umbria
EQUITAZIONE

art MA00060

Descrizione/Features

Tenaglia per unghie in ferro con manico rivestito in gomma.
Farrier nippers with rubber coating handle.

Misure/Sizes

15"



Umbria
EQUITAZIONE

art MA00061

Descrizione/Features

Tenaglia per unghie in ferro.
Farrier nippers.

Misure/Sizes

16"



FORGET
PROFESSIONAL
FARRIER TOOLS

art MA00070

Descrizione/Features

Tenaglia per unghie in acciaio inox.
Stainless Steel farrier nippers.

Misure/Sizes

16"



Umbria
equitazione srl
Official

www.umbriaequitazione.com

263

Mascalcia - Farrier Tools

FORGET
PROFESSIONAL
FARRIER TOOLS

art MA00065

Descrizione/Features

Tenaglia per unghie in acciaio inox.
Stainless Steel farrier nippers.

Misure/Sizes

16"



FORGET
PROFESSIONAL
FARRIER TOOLS

art MA00092

Descrizione/Features

Tenaglia per unghie in acciaio inox con taglio inclinato.
Stainless Steel farrier nippers with diagonal cut.

Misure/Sizes

16"



ARIEX

art MA00080

Descrizione/Features

Tenaglia per unghie da pareggio con taglio dritto.
Farrier nippers.

Misure/Sizes

16"



ARIEX

art MA00090

Descrizione/Features

Tenaglia per unghie con taglio inclinato.
Farrier nippers with diagonal cut.

Misure/Sizes

16"



ARIEX

art MA00081

Descrizione/Features

Tenaglia taglio chiodi ariex.
Ariex farrier nippers.

Misure/Sizes

16"



FORGET
PROFESSIONAL
FARRIER TOOLS

art MA00066

Descrizione/Features

Tenaglia per unghie in acciaio inox.
Stainless Steel farrier nippers.

Misure/Sizes

16"



art MA00081A



Descrizione/Features

Tenaglia taglio chiodi.
Farrier nippers.



art MA00063



Descrizione/Features

Tenaglia multi-funzioni.
Hoof nipper.



art MA00200



Descrizione/Features

Pinza multi-funzioni con manico rivestito in gomma.
Fence pliers with rubber coating handle.



art MA00062



Descrizione/Features

Tenaglia esploratrice in acciaio inox.
Stainless steel hoof tester.



art MA00093



Descrizione/Features

Tenaglia da forgia in ferro.
Farrier tongs.



art MA00040



Descrizione/Features

Tenaglia tirachiodi in ferro con manico rivestito in gomma.
Clinchers with rubber coated handle.



art MA00038



Descrizione/Features

Tenaglia tirachiodi in acciaio inox.
Stainless steel alligator clincher.



art MA00037



Descrizione/Features

Tenaglia tirachiodi con pallino.
Forged clincher.



art MA00045



Descrizione/Features

Tenaglia tirachiodi in acciaio inox.
Stainless steel alligator clincher.





art MA00046

Descrizione/Features

Tenaglia tirachiodi in acciaio inox.
Stainless steel clincher.



art MA00041

Descrizione/Features

Tenaglia tirachiodi.
Forged alligator clincher.



art MA00042

Descrizione/Features

Tenaglia tirachiodi con pallino.
Forged clincher.



Umbria
equitazione srl
Official



art MA00009

Descrizione/Features

Lima-raspa Eco.line completa con manico.
Hoof rasp with handle.

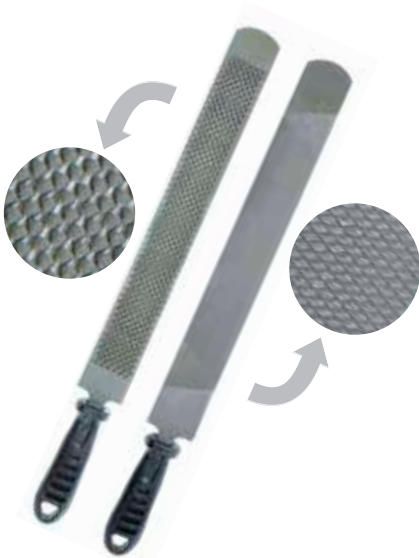

art MA00010

Descrizione/Features

Lima-raspa Double.
Double hoof rasp.

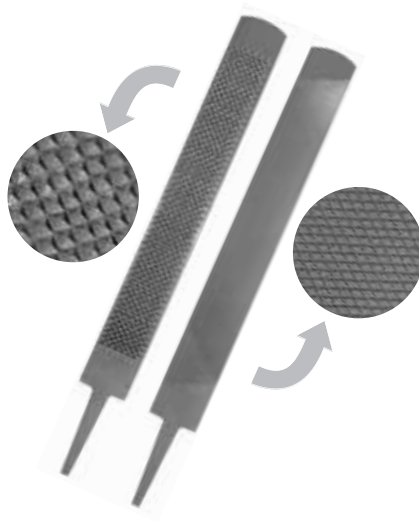

art MA00012

Descrizione/Features

Lima-raspa professionale Save Edge.
Save Edge hoof rasp.

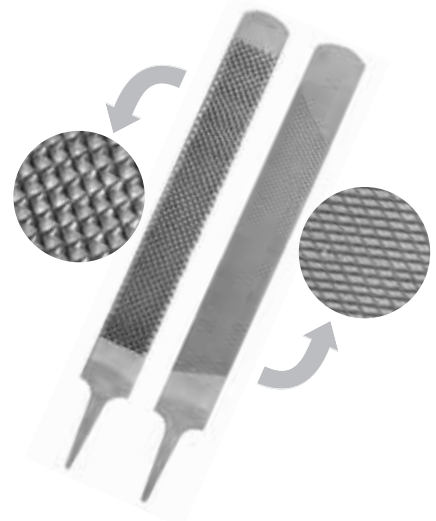

art MA00020

Descrizione/Features

Lima-raspa professionale Bassoli.
Bassoli hoof rasp.

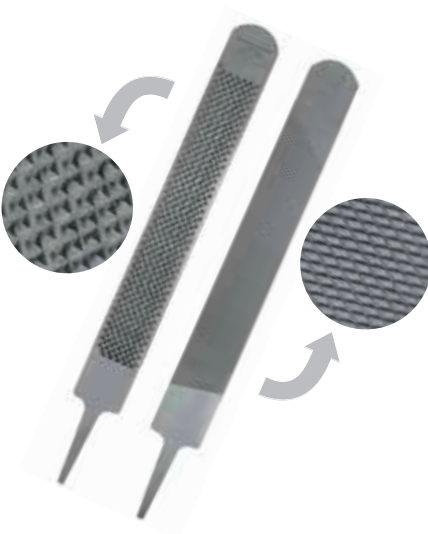

art MA00023

Descrizione/Features

Lima-raspa professionale Mercury.
Mercury hoof rasp.

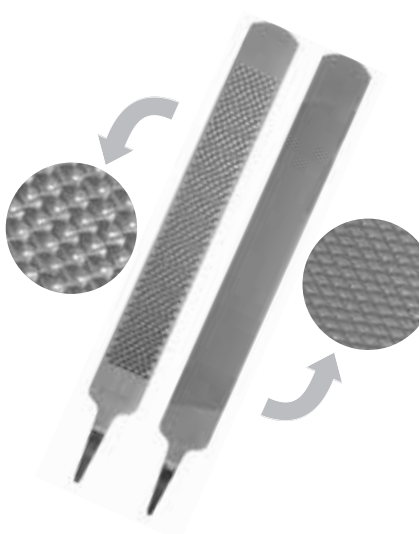

art MA00022

Descrizione/Features

Raspa mezza tonda Bassoli.
Half round rasp.

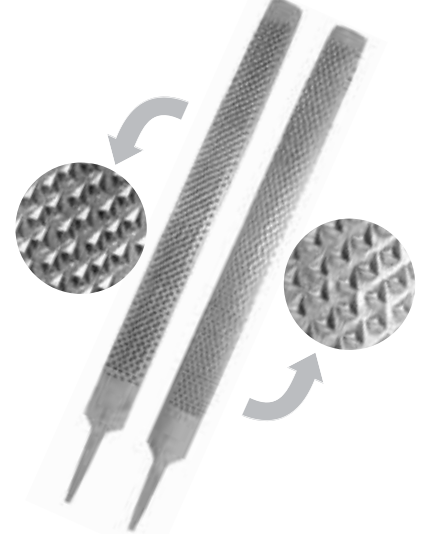

FORGET
PROFESSIONAL
FERRIER TOOLS

art MA00031

Descrizione/Features

Martello professionale plastificato.
Nylon Hammer with wooden handle.



FORGET
PROFESSIONAL
FERRIER TOOLS

art MA00030

Descrizione/Features

Martello professionale in acciaio inox.
Stainless steel Hammer with wooden handle.



ARIEX

art MA00150

Descrizione/Features

Incastro per mascaia Royal.
Royal dovetail.



Umbria
EQUITAZIONE

art MA00050

Descrizione/Features

Manico per raspa in plastica.
Plastic handle for hoof rasp.



Umbria
EQUITAZIONE

art MA00050A

Descrizione/Features

Manico per raspa in gomma ergonomico.
Rubber handle for hoof rasp.



Umbria
EQUITAZIONE

art MA00051

Descrizione/Features

Manico per raspa in legno.
Wooden handle for hoof rasp.



Umbria
EQUITAZIONE

art MA00180

Descrizione/Features

Lima per denti curva con manico.
Tooth rasp with curved blade.



Umbria
EQUITAZIONE

art VA00802

Descrizione/Features

Torcinaso con catena e manico
in legno.
Chain end twitch. Strong chain
end on hard wood handle,
preferred by veterinarians



Umbria
EQUITAZIONE

art. MA00300

Misuratore livello zoccoli in
metallo. Misura unica.

Metal hoof leveler. One size.



Umbria
EQUITAZIONE

art. MA00181

Apribocca in acciaio inox
con attacchi in cuoio. Misura
Unica. Colore Unico.
Speculum with webbing.
Completed with nylon
web and SS buckle.





art MA00101

Descrizione/Features

Scassachiodi in ferro.
Black hoof buffer.



art MA00103

Descrizione/Features

Incassino + Scassachiodi in acciaio inox.
SS Clinch groovers.



art MA00103A

Descrizione/Features

Incassino doppio in acciaio inox.
SS Clinch groovers.



Umbria
equitazione srl
Official

www.umbriaequitazione.com

267

ARIEX

art MA00100

Descrizione/Features

Incassino doppio in acciaio inox.
SS Clinch groovers.



ARIEX

art MA00102

Descrizione/Features

Incassino + Scassachiodi in acciaio inox.
SS Clinch groovers.



ARIEX

art MA00110

Descrizione/Features

Coltellaccio con manico rivestito in gomma.
Tenaglia per unghie in ferro con manico rivestito in gomma.



art MA00111

Descrizione/Features

Coltellaccio in acciaio inox con manico rivestito in gomma.
SS Toeing knife with coating pvc handle.



art MA00111A

Descrizione/Features

Coltellaccio in acciaio inox con impugnatura ergonomica.
SS Toeing knife with coating rubber handle.



art MA00112

Descrizione/Features

Coltellaccio inox curvo con manico rivestito in gomma.
SS Toeing knife with coating rubber handle.



art MA00120

Descrizione/Features

Raschietto doppio taglio con manico in plastica.
Hoof knife with double edge and plastic ergonomic handle.



art MA00119

Descrizione/Features

Raschietto taglio DX/SX con manico in plastica. Venduto singolarmente.
Hoof knife with DX or SX edge and plastic ergonomic handle. Sold individually.



Umbria equitazione srl Official

art MA00123

Descrizione/Features

Raschietto doppio taglio con manico in plastica SoyoHQ.
Hoof knife with double edge and plastic ergonomic handle.



art MA00118

Descrizione/Features

Raschietto taglio DX/SX con manico in plastica ErgoLine. Venduto singolarmente.
Hoof knife with DX or SX edge and plastic ergonomic handle. Sold individually.



art MA00119A

Descrizione/Features

Raschietto doppio taglio con manico in legno.
Hoof knife with double edge and wooden handle.



art MA00121C

Descrizione/Features

Raschietto taglio DX/SX con manico in legno. Venduto singolarmente.
Hoof knife with DX or SX edge and wooden handle. Sold individually.



art MA00122

Descrizione/Features

Raschietto doppio taglio con manico in legno Basic Line.
Hoof knife with double edge and wooden handle.



art AG00180

Descrizione/Features

Raschietto per uova parassiti.
Bot egg knife with plastic ergonomic handle.



Descrizione/Features

Borsa da ferratura Hobby completa (vedi a lato).
Farrier's tool full set with cordura bag. (see below)



HOBBY

full set



Umbria
equitazione srl
Official

www.umbriaequitazione.com

269

Mascalcia - Farrier Tools

art MA00500

Descrizione/Features

Borsa da ferratura Hobby. Vendita senza accessori.
Farrier's tool cordura bag. Sold only bag.



art MA00400

Descrizione/Features

Kit per ferratura da viaggio.
Farrier's tool travel set.

TRAVEL

set



art MA00160

Descrizione/Features

Grembiule da maniscalco in pelle scamosciata con rinforzi.
Farrier apron in suede leather with reinforcements.

Colori/Colors

■ testa di moro/dark brown



art MA00161

Descrizione/Features

Grembiule da maniscalco in pelle con rinforzi.
Farrier apron in leather with reinforcements.

Colori/Colors

■ testa di moro/dark brown



art FE00010 - FE00011



Descrizione/Features

Ferri Italiani con barbette. Disponibili anteriori, posteriori lisci, posteriori ramponati. Venduti in coppia.
Horseshoes with clips. Available front, hind straight, hind heeled. Sold in pairs.

Misure/Sizes

FE00010 : 2 - 3 - 4 - 4^{1/2} - 5
FE00011 : 6 - 7 - 8 - 9

SELLA

Italiano

- Materiale certificato di ottima qualità per essere ben lavorato anche a freddo e durare nel tempo
- Forma perfetta del ferro, frutto di oltre 30 anni di esperienza
- Barbette robuste e rifilate a punta con classico profilo a V rovesciata
- Stampe e controstampi ben allineate per chiodi JC-VF
- perfetta posizione della stampatura sulla branca esterna da magro a grasso senza essere "invadente"
- Stampatura branca interna a magro
- Svasatura della volta del ferro sul lato superiore (in prossimità della suola)
- Accenno di orlatura esterna delle branche

- certified quality material to be worked well even when cold and stand the test of time

- Perfect shape of the iron, the result of over 30 years of experience
- Strong and trimmed clips with classic inverted V-shaped profile
- Prints and counterprinting well aligned for nails JC-VF

-perfect location on the external branch of printing from thin to fat without being "pushy"

- Punching internal branch to lean
- Firing of the time-iron on the top (near the sole "
- Hint of hemming the outer branches



art FE00081

Descrizione/Features

Ferri Olandesi con barbette a filo. Disponibili anteriori, posteriori lisci. Venduti in coppia.
Horseshoes with clips. Available front, hind straight. Sold in pairs.

Misure/Sizes

4x0 - 3x0 - 2x0 - 0 - 1 - 2 - 3 - 4

DF

La linea DF è stata sviluppata per sfruttare le nuove tecniche avanzate. Innovazioni come il brevettato Radius Clips e nuovi concetti come il Grand Prix Hinds, trovano beneficio dal disegno di questa linea.

ST line has been developed to take advantage of new advanced techniques. Innovations such as the patented Radius Clips and new concepts such as the Grand Prix Hinds, find benefit from the design of this line.



art FE00080 - FE00080A

Descrizione/Features

Ferri Olandesi con barbette. Disponibili anteriori, posteriori lisci. Venduti in coppia.
Horseshoes with clips. Available front, hind straight. Sold in pairs.

Misure/Sizes

FE00080 : 5x0 - 4x0 - 3x0 - 2x0 - 0 - 1 - 2 - 3
FE00080A : 8x0 - 7x0 - 6x0

SN

Linea base SN dalla forma facile e regolare. Costruito in acciaio di qualità superiore, questo ferro, grazie all'attenzione di ogni minimo dettaglio, è la prima scelta dei maniscalchi professionisti di tutto il mondo.

SN baseline shaped and easy to adjust. Built in high quality steel, iron this, thanks all'attenzione of every detail, is the first choice of professional farriers from all over the world.



art FE00081A

Descrizione/Features

Ferri Olandesi anteriori con 2 barbette a filo. Venduti in coppia.
Front horseshoes with clips. Sold in pairs.

Misure/Sizes

4x0 - 3x0 - 2x0 - 0 - 1 - 2 - 3 - 4

Quarter DF

La linea DF è stata sviluppata per sfruttare le nuove tecniche avanzate. Questa linea si è ampliata per soddisfare le esigenze specifiche dei maniscalchi, come la ferratura dei cavalli americani.

DF line has been developed to take advantage of new advanced techniques. This line has expanded to meet the specific needs of farriers, shoeing horses as Americans.



art FE00082

Descrizione/Features

Ferri Olandesi posteriori con 1 barbetta a filo. Venduti in coppia.
Hind horseshoes with clips. Sold in pairs.

Misure/Sizes

4x0 - 3x0 - 2x0 - 0 - 1 - 2 - 3 - 4

Special ST

La linea ST è stata sviluppata per sfruttare le nuove tecniche avanzate. Innovazioni come il brevettato Radius Clips e nuovi concetti come il Grand Prix Hinds, trovano beneficio dal disegno di questa linea.

ST line has been developed to take advantage of new advanced techniques. Innovations such as the patented Radius Clips and new concepts such as the Grand Prix Hinds, find benefit from the design of this line.



Umbria equitazione srl
Official

Descrizione/Features

Ferri da quarter horse. Disponibili Anteriori (serie **F**) e Posteriori (serie **B**). Venduti in coppia.
Quarter horse horseshoes. Available in: front (F series), hind (B series). Sold in Pairs.

Misure/Sizes
000 - 00 - 0 - 1



F | front



B | back

Descrizione/Features

Ferri da quarter horse modello Slider. Venduti in coppia.
Quarter horse Slider horseshoes. Sold in Pairs.

Misure/Sizes
S1 - S2 - S3



S | series



Umbria
equitazione srl
Official



Descrizione/Features

Ferri anteriori in alluminio. Venduti in coppia.
Front aluminum horseshoes with clips. Sold in pairs.

Misure/Sizes
FE00120 : 3 - 4
FE00130 : 5 - 6
FE00140 : 7 - 8



Descrizione/Features

Pianelle in alluminio con barbetta. Vendute in coppia.
Aluminum bar with clip. Sold in pairs.

Misure/Sizes
FE00141 : 2 - 3 - 4 - 5
FE00142 : 6 - 7 - 8



Descrizione/Features

Pianelle in ferro con barbetta. Vendute in coppia.
Steel bar with clip. Sold in pairs.

Misure/Sizes
2 - 3 - 4 - 5 - 6 - 7 - 8



Descrizione/Features

Rialzi in plastica per ferratura. Venduti in coppia.
Plastic pad wedge bar. Sold in pairs.

Misure/Sizes
1 small - 2 medium - 3 large



Descrizione/Features

Pianelle in plastica per ferratura. Vendute in coppia.
Plastic pad wedge. Sold in pairs.

Misure/Sizes
1 small - 2 medium - 3 large



Descrizione/Features

Paraferri in gomma naturale. Venduti in coppia.
Short over-reach boot. Natural rubber. Sold in pairs.

Misure/Sizes
S - M - L - XL



art CH00197



Descrizione/Features

Rampone modello MX24HS con punta antiscivolo. Venduto in confezione da 10 Pz.
Stud MX24HS model. Sold in Packing of 10 Pcs.



altezza - eight (mm)	6
grip da * a *** grip from * to ***	*
testa - head	esagonale hexagonal 12 mm
foro - drill	Ø 8mm

art CH00193



Descrizione/Features

Rampone modello MX10S con punta antiscivolo. Venduto in confezione da 10 Pz.
Stud MX10S model. Sold in Packing of 10 Pcs.



altezza - eight (mm)	11
grip da * a *** grip from * to ***	**
testa - head	quadrata / square 10 mm
foro - drill	Ø 8mm

art CH00194



Descrizione/Features

Rampone modello MX18S con punta antiscivolo. Venduto in confezione da 10 Pz.
Stud MX18S model. Sold in Packing of 10 Pcs.



altezza - eight (mm)	14
grip da * a *** grip from * to ***	**
testa - head	quadrata / square 10 mm
foro - drill	Ø 8mm

art CH00192



Descrizione/Features

Rampone modello MX50S con punta antiscivolo. Venduto in confezione da 10 Pz.
Stud MX50S model. Sold in Packing of 10 Pcs.



altezza - eight (mm)	20,5
grip da * a *** grip from * to ***	***
testa - head	quadrata / square 12 mm
foro - drill	Ø 8mm

art CH00180



Descrizione/Features

Punta antiscivolo in tungsteno CW0. Ø 4,5 mm. Vendita in confezione da 100 Pz.
Tungsten pin CW0. ø 4,5 mm. Sold in Packing of 100 Pcs.



100
Pcs.



art FE00152



Descrizione/Features

Tappi in gomma per ramponi. Confezione da 20 pezzi.
Rubber shoes stoppers. Sold in packing of 20 pcs.



20
Pcs.

art CH00191



Descrizione/Features

Valigetta completa Michel Vaillant. Contenuto: una chiave per ramponi con filiera, una brugola, 8 tappi in ferro, 8 ramponi da 20,5 mm, 8 ramponi da 11 mm.
Blue mini stud box including assorted W3/8 tungsten studs, in two sizes, for hard or softer ground, plugs and wrenches. Composition : 8 studs MX10S + 8 studs MX50S + 8 plugs FW3/8 + hexagonal key 3/16" + 1 T tap W3/8. Size : 140x130x35 mm. Weight 525 g.



art CH00195



Descrizione/Features

Valigetta completa. Contenuto: una chiave per ramponi con filiera, una brugola, 10 tappi per ramponi, 10 tappi in ferro, 8 ramponi da 20,5 mm, 8 ramponi da 14 mm ed una spazzola scovolino.
Stud box including assorted tungsten studs, in two sizes, for hard or softer ground, plugs and wrenches. Composition : 8 x 20,5 mm studs + 8 x 14 mm studs + 10 rubber shoes stoppers + hexagonal key + 1 T tap.



art CH00200



Descrizione/Features

Chiave per ramponi con filiera.
Screwing key.



art MA00601



Descrizione/Features

Filiera per ramponi con impugnatura in plastica.
Screwing key.



FJ Chiodi per cavalli da corsa

Nails for race horses

Nail anatomy:
 - Nail head: The part of the nail that is visible above the hoof wall.
 - Nail body: The part of the nail that is embedded in the hoof wall.
 - Nail tip: The sharp end of the nail.
 - Nail base: The part of the nail that is embedded in the hoof wall.
 - Nail hole: The hole in the hoof wall through which the nail is driven.
 - Nail groove: The groove in the hoof wall that holds the nail.
 - Nail flange: The flange of the nail that fits into the hoof wall.
 - Nail head: The part of the nail that is visible above the hoof wall.
 - Nail body: The part of the nail that is embedded in the hoof wall.
 - Nail tip: The sharp end of the nail.
 - Nail base: The part of the nail that is embedded in the hoof wall.
 - Nail hole: The hole in the hoof wall through which the nail is driven.
 - Nail groove: The groove in the hoof wall that holds the nail.
 - Nail flange: The flange of the nail that fits into the hoof wall.

FJ00 | **FJ0** | **FJ1** | **FJ2** | **FJ3**

40 mm | 47 mm | 44 mm | 47 mm | 50 mm

VF Chiodi per cavalli da passeggiata

Nails for saddle horses

Nail anatomy:
 - Nail head: The part of the nail that is visible above the hoof wall.
 - Nail body: The part of the nail that is embedded in the hoof wall.
 - Nail tip: The sharp end of the nail.
 - Nail base: The part of the nail that is embedded in the hoof wall.
 - Nail hole: The hole in the hoof wall through which the nail is driven.
 - Nail groove: The groove in the hoof wall that holds the nail.
 - Nail flange: The flange of the nail that fits into the hoof wall.
 - Nail head: The part of the nail that is visible above the hoof wall.
 - Nail body: The part of the nail that is embedded in the hoof wall.
 - Nail tip: The sharp end of the nail.
 - Nail base: The part of the nail that is embedded in the hoof wall.
 - Nail hole: The hole in the hoof wall through which the nail is driven.
 - Nail groove: The groove in the hoof wall that holds the nail.
 - Nail flange: The flange of the nail that fits into the hoof wall.

VF4 | **VF5** | **VF6** | **VF6,5** | **VF7** | **VF7,5** | **VF8**

44 mm | 47 mm | 51 mm | 54 mm | 57 mm | 60 mm | 62 mm

JC Chiodi per cavalli sportivi e da passeggiata

Nails for saddle horses

Nail anatomy:
 - Nail head: The part of the nail that is visible above the hoof wall.
 - Nail body: The part of the nail that is embedded in the hoof wall.
 - Nail tip: The sharp end of the nail.
 - Nail base: The part of the nail that is embedded in the hoof wall.
 - Nail hole: The hole in the hoof wall through which the nail is driven.
 - Nail groove: The groove in the hoof wall that holds the nail.
 - Nail flange: The flange of the nail that fits into the hoof wall.
 - Nail head: The part of the nail that is visible above the hoof wall.
 - Nail body: The part of the nail that is embedded in the hoof wall.
 - Nail tip: The sharp end of the nail.
 - Nail base: The part of the nail that is embedded in the hoof wall.
 - Nail hole: The hole in the hoof wall through which the nail is driven.
 - Nail groove: The groove in the hoof wall that holds the nail.
 - Nail flange: The flange of the nail that fits into the hoof wall.

JC00 | **JC0** | **JC1** | **JC2** | **JC3** | **JC4**

42 mm | 44 mm | 44 mm | 52 mm | 56 mm | 60 mm

ASM Chiodi per cavalli westerni

Nails for quarter horses

Nail anatomy:
 - Nail head: The part of the nail that is visible above the hoof wall.
 - Nail body: The part of the nail that is embedded in the hoof wall.
 - Nail tip: The sharp end of the nail.
 - Nail base: The part of the nail that is embedded in the hoof wall.
 - Nail hole: The hole in the hoof wall through which the nail is driven.
 - Nail groove: The groove in the hoof wall that holds the nail.
 - Nail flange: The flange of the nail that fits into the hoof wall.
 - Nail head: The part of the nail that is visible above the hoof wall.
 - Nail body: The part of the nail that is embedded in the hoof wall.
 - Nail tip: The sharp end of the nail.
 - Nail base: The part of the nail that is embedded in the hoof wall.
 - Nail hole: The hole in the hoof wall through which the nail is driven.
 - Nail groove: The groove in the hoof wall that holds the nail.
 - Nail flange: The flange of the nail that fits into the hoof wall.

ASM 4 | **ASM 4,5** | **ASM 5**

45 mm | 47,5 mm | 50 mm

Modello/Model	Confezione/Box 100 Pcs	Confezione/Box 250 Pcs	Confezione/Box 500 Pcs
FJ00	-	-	CH00088
FJ0	CH00155	-	CH00089
FJ1	CH00156	-	CH00090
FJ2	CH00157	-	CH00091
FJ3	CH00158	-	CH00092
VF4	CH00151	-	CH00041
VF5	CH00150	-	CH00050
VF6	CH00160	-	CH00060
VF6,5	CH00161	-	CH00070
VF7	CH00166	-	CH00080
VF7,5	CH00162	CH00082	-
VF8	CH00167	CH00081	-
JC00	CH00128	-	CH00009
JC0	CH00129	-	CH00010
JC1	CH00130	-	CH00020
JC2	CH00140	-	CH00030
JC3	CH00165	-	CH00040
JC4	-	-	CH00042
ASM4	-	-	CH00100
ASM4,5	-	-	CH00110
ASM5	-	-	CH00120



MASCAJCIA

JCF



Chiodi Standard
Stile Francese
Collo Lungo

Standard Nails
French Style
Long Neck



Modello/Model	Confezione/Box 100 Pcs	Confezione/Box 250 Pcs
JC00	-	CM00009
JC0	-	CM00010
JC1	-	CM00020
JC2	-	CM00030
JC3	-	CM00031

VFF



Chiodi Standard
Stile Francese
Collo Lungo

Standard Nails
French Style
Long Neck



Modello/Model	Confezione/Box 100 Pcs	Confezione/Box 250 Pcs
VF4	-	CM00080
VF5	-	CM00090
VF6	-	CM00100
VF6,5	-	CM00110
VF7	-	CM00120
VF7,5	-	CM00130
VF8	CM00131	-

FJ



Chiodi Standard
Stile Francese
Collo Corto

Standard Nails
French Style
Short Neck



Modello/Model	Confezione/Box 100 Pcs	Confezione/Box 250 Pcs
FJ00	-	CM00039
FJ0	-	CM00040
FJ1	-	CM00050
FJ2	-	CM00060
FJ3	-	CM00070

EXL



Testa Rettangolare
Stile Francese
Lama Lunga e Sottile

Rectangular Head
French Style
Long & Thin Blade



Modello/Model	Confezione/Box 100 Pcs	Confezione/Box 250 Pcs
EXL3	-	CM00153

ESL



Testa Rettangolare
Stile Europeo
Lama Lunga e Sottile

Rectangular Head
European Style
Long & Thin Blade



Modello/Model	Confezione/Box 100 Pcs	Confezione/Box 250 Pcs
ESL3	-	CM00152
ESL4	-	CM00150
ESL4	-	CM00151



HOOF CARE





LIBERTY
A SINCE 1877

FJ



Chiodi Standard
Stile Francese
Collo Corto

Standard Nails
French Style
Short Neck



Modello/Model	Confezione/Box 100 Pcs	Confezione/Box 250 Pcs
FJ0	-	CH00320
FJ1	-	CH00321

LX



Chiodi Standard
Stile Francese
Collo Lungo

Standard Nails
French Style
Long Neck



Modello/Model	Confezione/Box 100 Pcs	Confezione/Box 250 Pcs
LX50	-	CH00339
LX55	-	CH00340
LX60	-	CH00341



Umbria
equitazione srl
Official

www.umbriaequitazione.com

275

Mascalcia - Farrier Tools



ESL



Testa Rettangolare
Stile Europeo
Lama Lunga e Sottile

Rectangular Head
European Style
Long & Thin Blade



Modello/Model	Confezione/Box 100 Pcs	Confezione/Box 250 Pcs
ESL3	-	CH00313
ESL4	-	CH00314

JC



Chiodi Standard
Stile Francese
Collo Lungo

Standard Nails
French Style
Long Neck



Modello/Model	Confezione/Box 100 Pcs	Confezione/Box 250 Pcs
JC1	-	CH00301
JC2	-	CH00302

CHIODI ANTISCIVOLO MORDAX

JC



Chiodi Standard
Stile Francese
Collo Lungo

Standard Nails
French Style
Long Neck



Modello/Model	Confezione/Box 50 Pcs	Confezione/Box 100 Pcs
JC1	CH00171	-
JC2	CH00172	-
JC3	CH00173	-

VF



Chiodi Standard
Stile Francese
Collo Lungo

Standard Nails
French Style
Long Neck



Modello/Model	Confezione/Box 50 Pcs	Confezione/Box 100 Pcs
VF4	CH00174	-
VF5	CH00175	-
VF6	CH00176	-
VF7	CH00177	-

Handy

heiniger

Stabile e durevole, dal design compatto e maneggevole e di semplice utilizzo. Fornita con kit completo, pettini, cacciavite, olio lubrificante, pennello detergente e manuale d'istruzioni. Il tutto confezionato in una valigetta resistente e pratica.

Easy to handle, reliable and durable horse clipper that also performs well on daily cattle.

Incl. carry case, blades, screwdriver, oil, brush.



art. VA00610
701-800 230V EU

Sistema di taglio / Cutting system	Set di lame professionali / Professional blade set
Alimentazione / Mains voltage	230 - 240 V 50Hz
Potenza / Motor Output	120 W
Velocità di taglio / Rpm	Circa / Approx 3200 rpm.
Rumorosità / Noise emission	75 dB (A)
Dimensioni / Dimensions	79 x 72 x 290 mm.
Peso / Weight	Circa / Approx 1250 gr.

276

www.heiniger.it

Tosatrici - Clippers



Progress

heiniger

Grazie alla sua impugnatura ergonomica e leggera ed al suo funzionamento silenzioso, questa tosatrice è la miglior scelta per la tosatura di cavalli particolarmente nervosi. Ha un dispositivo di sicurezza contro il sovraccario e non ha nessuna uscita d'aria molesta. La potenza del motore a magnete permanente è paragonabile ad un motore universale di 150 W. Fornita con kit completo di pettini, cacciavite, olio lubrificante, pennello detergente e manuale d'istruzioni, in una pratica e resistente valigetta.

Thanks to a slim grip, quiet operation, lightweight yet robust structure incorporating a powerful permanent magnet motor being comparable to a conventional motor of 150 Watts the Progress is the choice for clipping nervous horses.

Incl. carry case, blades, screwdriver, oil, brush.

Sistema di taglio / Cutting system	Set di lame professionali / Professional blade set
Alimentazione / Mains voltage	230 - 240 V 50Hz
Potenza / Motor Output	80 W
Velocità di taglio / Rpm	Circa / Approx 2200 rpm.
Rumorosità / Noise emission	70 dB (A)
Lunghezza / Length	280 mm.
Peso / Weight	Circa / Approx 970 gr.



art. VA00628
707-500 230V EU

Cordless

heiniger

Sicura e maneggevole, grazie all'accumulatore 2.0 Ah NiCd si ricarica in meno di un'ora e permette un tempo d'indipendenza dalla fonte di energia superiore ad un ora. Il dispositivo di protezione contro il sovraccarico termico prolunga la durata della batteria. La soluzione semplice per la tosatura di bestiame ed equini. Fornita con kit completo di pettini, cacciavite, olio lubrificante, pennello detergente e manuale d'istruzioni, in una pratica e resistente valigetta.

The 2.0 Ah NiCd battery offers more than 1 hour of independent operation remote of mains power. A quick recharge time of less than 1 hour. Unique deep discharge protection switch extends battery life. The simple way for horse and cattle clipping. Incl. carry case, blades, screwdriver, oil, brush.



art. VA00605
701-700 230V EU

Sistema di taglio / Cutting system	Set di lame professionali / Professional blade set
Batteria / Battery	NiCd 7,2 V 2000 mAh
Potenza / Motor Output	35 W
Velocità di taglio / Rpm	Circa / Approx 2000 rpm.
Tempo di ricarica / Charging time	Circa / Approx 90 min.
Rumorosità / Noise emission	72 dB (A)
Dimensioni / Dimensions	80 x 72 x 310 mm.
Peso / Weight	Circa / Approx 1200 gr.

Xtra



Questa tosatrice solida e potente, è dotata di un sistema di pressione a forcelle pendenti patentato che regola la pigiatura manuale. Di conseguenza l'usura delle lame è ridotta del 50%. Fornita con kit completo di pettini, cacciavite, olio lubrificante, pennello detergente e manuale d'istruzioni, in una pratica e resistente valigetta.

This powerful electric shearing handpiece has a patented floating fork system to provide an even pressure across the comb and cutter, using less pressure and extends the life of the comb and cutter by up to 50%.
Incl. carry case, cutter, screwdriver, oil, brush.



Tosatrice
art. VA00607
712-600 230V EU

Pettine
art. VA00637
714-090



Shattle

Questo pettine a testina normale trasforma una tosatrice per ovini in una per bestiame e cavalli.
To clip cattle on an electric or mechanical shearing handpiece with a standard cutter.



Bestiame / Cattle



Cavallo / Horse



Ovino / Sheep

Sistema di taglio / Cutting system	Set di lame professionali / Professional blade set
Alimentazione / Mains voltage	230 - 240 V 50Hz
Potenza / Motor Output	320 W
Velocità di taglio / Rpm	Circa / Approx 2400 rpm.
Rumorosità / Noise emission	80 dB (A)
Dimensioni / Dimensions	80 x 95 x 350 mm.
Peso / Weight	Circa / Approx 1560 gr.



Bestiame / Cattle



Cavallo / Horse

Xperience



La giusta combinazione di potenza, ergonomia e silenziosità per questa tosatrice. La sua tecnologia avanzata entusiasma tutti i professionisti. Unico di questo prodotto è il collegamento stabile in fibra di vetro rinforzata tra la testa e la custodia. Fornita con kit completo di pettini, cacciavite, olio lubrificante, pennello detergente e manuale d'istruzioni, in una pratica e resistente valigetta.

The newest machine by Heiniger. It combines the combination of a powerful and still ergonomic and light machine. With cutting-edge technology, this new machine is exciting for both people and animals. The unique aspect about this product is the innovative, stable connection between the clipping head and housing.

Incl. carry case, blades, screwdriver, oil, brush.



art. VA00636
708-000 230V EU

Sistema di taglio / Cutting system	Set di lame professionali / Professional blade set
Alimentazione / Mains voltage	230 - 240 V 50Hz
Potenza / Motor Output	200 W
Velocità di taglio / Rpm	Circa / Approx 2500 rpm.
Rumorosità / Noise emission	70 dB (A)
Lunghezza / Length	301 mm.
Peso / Weight	Circa / Approx 1240 gr.

Saphir



Grazie ad una nuovissima generazione di batterie agli ioni di litio, la durata della tosatura raggiunge i 50 - 60 min. Inoltre una batteria di riserva ed un tempo di ricarica inferiore ai 45 minuti, permettono una tosatura continua senza inutili tempi di attesa. La tosatrice viene fornita insieme alla testina, al caricatore, due batterie, olio lubrificante, pennello per la pulizia e manuale d'istruzioni.

Independent operation up to 60 minutes thanks to high performance battery with the latest lithium-ionic technology. Less than 45 minutes charging time for continuous clipping. Detachable Saphir blade systems compatible with clippers from Andis, Moser, Oster and Wahl. Incl. carry case, clipping blades, charger unit, oil, brush and instruction manual.



art. VA00594
707-800 230V EU



Gatto / Cat



Bestiame / Cattle



Cane / Dog



Cavallo / Horse

Sistema di taglio / Cutting system	Set di lame professionali / Professional blade set
Batteria / Battery	Li-Ion da 1400 mAh a 7,4 V
Potenza / Motor Output	35 W
Velocità di taglio / Rpm	Circa / Approx 2650 rpm.
Tempo di ricarica / Charging time	Circa / Approx 45 min.
Rumorosità / Noise emission	72 dB (A)
Dimensioni / Dimensions	79 x 72 x 290 mm.
Peso / Weight	Circa / Approx 440 gr.

Horse Standard

Lama standard per cavalli



art. VA00613	703-530 set 31/15
Lunghezza pelo dopo la tosatura / coat length after clipping	2 - 4 mm
Lametta inferiore 31 Bottom blade 31	
Lametta superiore 15 Top blade 15	



Horse F

Lama per cavalli



art. VA00614	703-560 set 31F/15
Lunghezza pelo dopo la tosatura / coat length after clipping	1 - 2 mm
Lametta inferiore 31F Bottom blade 31F	
Lametta superiore 15 Top blade 15	



Shattle

Lama per bestiame



art. VA00637	714-090
--------------	---------



Solo per I Only for
Xtra



Jet+Ovina

Lama standard per ovini



art. VA00616	714-001 Jet/Ovina set
Lama inferiore Ovina 77 mm Ovina Bottom blade 77 mm	
Lama superiore Jet 4,4 mm Jet Top blade 4,4 mm	

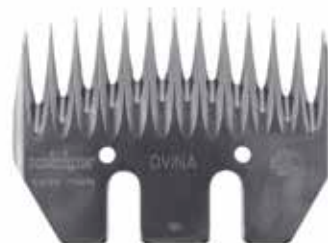

for
Xtra



Saphir 10

Lama saphir 10



art. VA00594A	707-930
Lunghezza pelo dopo la tosatura / coat length after clipping	1,8 mm
Lametta inferiore 10 Bottom blade 10	



Le testine Saphir sono compatibili con tosatrici di altre marche, quali Andis, Moser, Oster serie A5 e Wahl. Saphir blades are compatible with other brands of hair clippers, which Andis, Moser, Oster A5 series and Wahl.



Saphir 40

Lama saphir 40



art. VA00594B	707-910
Lunghezza pelo dopo la tosatura / coat length after clipping	0,6 mm
Lametta inferiore 40 Bottom blade 40	



Le testine Saphir sono compatibili con tosatrici di altre marche, quali Andis, Moser, Oster serie A5 e Wahl. Saphir blades are compatible with other brands of hair clippers, which Andis, Moser, Oster A5 series and Wahl.



Standard

Lama standard



art. VA00621	18961
Lunghezza pelo dopo la tosatura / coat length after clipping	2 - 4 mm
Lametta inferiore 31 Bottom blade 31	
Lametta superiore 15 Top blade 15	



Fine

Lama fine



art. VA00622	18963
Lunghezza pelo dopo la tosatura / coat length after clipping	1 - 2 mm
Lametta inferiore 31F Bottom blade 31F	
Lametta superiore 15 Top blade 15	



accessories

Heiniger

www.umbriaequitazione.com

279

Tosatrici - Clippers

fig.1

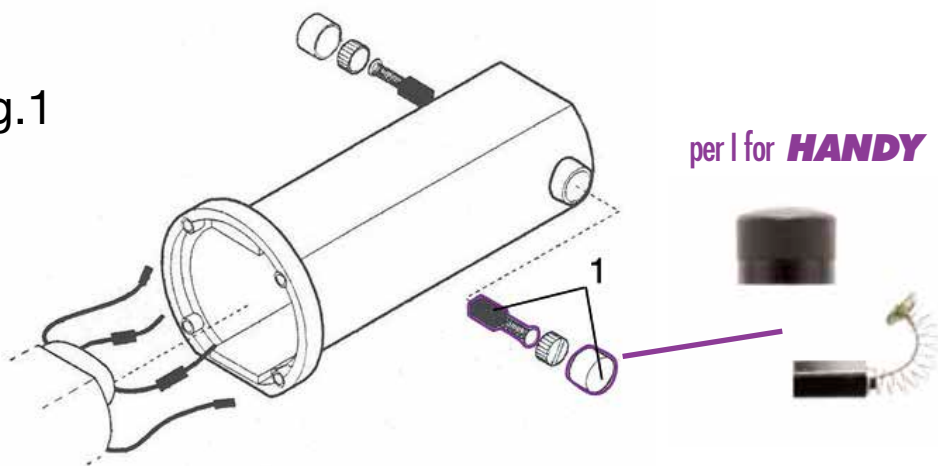

per I for **HANDY**



Umbria equitazione srl Official

fig.2

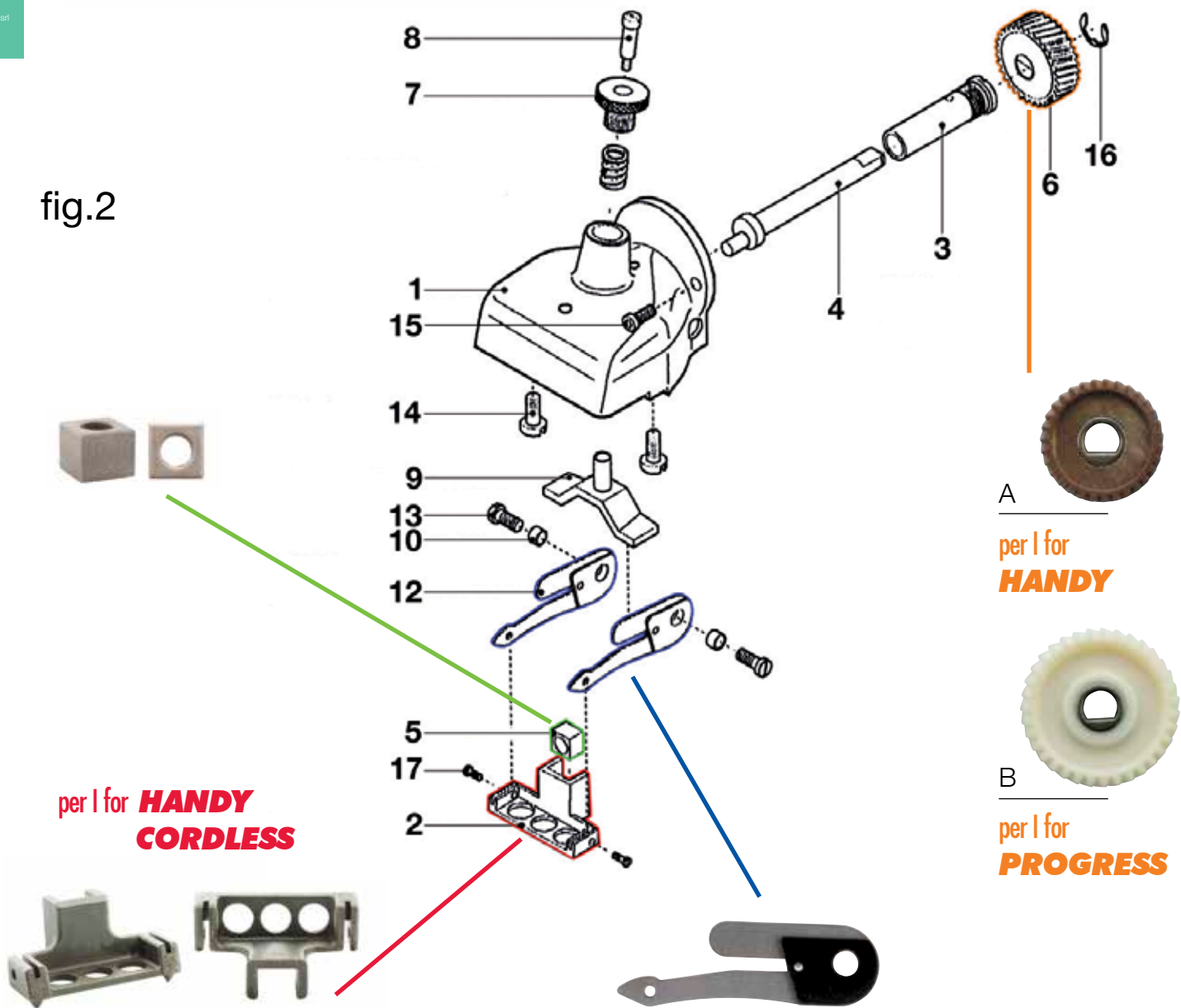

per I for **HANDY CORDLESS**

A
per I for **HANDY**

B
per I for **PROGRESS**

fig. 1

1- spazzole in carbone con molla + bussola di coperchio
carbon brushes with spring + protection cap
art. VA00627A

fig. 2

2 - leva orientabile
driving carrier
art. VA00603

5 - quadro dell'eccentrico
crank drive block
art. VA00627

12 - molla a lamina
laminated spring
art. VA00604

6A - ruota dentata per tosatrice Handy
cogwheel for handy clipper
art. VA00615

6B - ruota dentata per tosatrice Progress
cogwheel for Progress clipper
art. VA00615B

N.B. Gli articoli contrassegnati sono in pronta consegna, mentre tutti gli altri sono disponibili solo su ordinazione.

N.B. Items marked with are ready for delivery, while all the others are only available to order.

Styling III **MOSER®**

Tosatrice per animali professionale a batteria completa con 4 rialzi da 3,6,9,12 mm, base di ricarica, alimentatore switching da rete, spazzolino ed olio.

Cordless, efficient operation due to 70 min. battery power. Corded-operation also possible during charging.

Inclusive: 4 slide-on attachment combs 3, 6, 9, 12 mm, charging stand, energy-efficient plug-in transformer, cleaning brush, oil.



art. VA00611
1853-0060



Larghezza lama del pettine / Cutter comb width	46 mm.
Lunghezza di taglio / Cutting length	da 0,1 a 3 mm.
Alimentazione / Main voltage	220-240 V, 50-60 Hz
Autonomia a batteria carica / Operating time	Circa / Approx 45 min.
Dimensioni / Dimensions	175 x 50 x 45 mm.
Peso / Weight	Circa / Approx 300 gr.

280

www.umbriaequitazione.com



1400 **MOSER®**

Tosatrice professionale dotata di lama di precisione cromata per una durata particolarmente lunga. Leggera e maneggevole, per un taglio scorrevole in tutta sicurezza. Facile da usare e comoda da portare sempre con se anche in viaggio.

Powerful animal clippers. Powerful, oscillating armature motor with long service life. Tried and tested countless times.

Precision-ground, stainless steel blade set for even longer service life. Cutting-length adjustment: 6 lock-in positions from 0.1 to 3 mm. 2 m cable length with hanging loop.



art. VA00617
1400-0074



Larghezza lama del pettine / Cutter comb width	46 mm.
Lunghezza di taglio / Cutting length	da 0,1 a 3 mm.
Motore / Drive unit	Efficient DC motor a basso livello di rumore / low noise
Alimentazione / Main voltage	230 V, 50 Hz
Dimensioni / Dimensions	175 x 72 x 50 mm.
Peso / Weight	Circa / Approx 560 gr.

Tosatrici - Clippers

Max 45 **MOSER®**

La tosatrice Moser Professional è estremamente robusta ed è perfetta per la tosatura completa del cane o per la tosatura di precisione del vostro cavallo. La confezione include: 1 testina di taglio da 3 mm, spazzolino pulisci lama e olio lubrificante.

Professional corded animal clipper. Clipping of large animals. Optional: extensive range of quick-release blade sets adjusted for all fur types and cutting lengths.



art. VA00635
1245-0066



Larghezza lama del pettine / Cutter comb width	46 mm.
Lunghezza di taglio / Cutting length	Da 0,1 a 3 mm.
Alimentazione / Main voltage	*230-240 V, 50-60 Hz
Lunghezza cavo / Cable length	3 m.
Dimensioni / Dimensions	*185 x 46 x 48 mm.
Peso / Weight	*Circa / Approx 390 gr.

Adelar **MOSER®**

Tosatrice professionale Moser modello Adelar fornita con due batterie di ricambio e con caricabatteria. Avviso a LED di sostituzione batteria. Il set delle lame in dotazione è particolarmente adatto per le finiture.

Stands alone in its class - effective through all coat types, ideal for equine enthusiasts who demand professional results. Minimal vibration and compact design ensures effective performance every time.



art. VA00634
1854-0460



Lunghezza di taglio / Cutting	0,7 - 3 mm
Velocità di taglio / RPM	Circa / Approx 5.000 rpm
Motore / Drive unit	2.3 V con silenziatore / DC motor with silencing
Tempo per ricarica batteria / Charging time	Carica in / Charging within 75 min
Autonomia a batteria carica / Operating time	Sopra gli / Up to 80 min.
Dimensioni / Dimensions	170 x 50 x 50 mm
Peso / Weight	Circa / Approx 280 gr. (con lame) (with blade set)



Avalon

MOSER®

Tosatrice Moser AVALON a batteria ricaricabile. La confezione contiene: 2 lame di ricambio, olio, carica-batteria, imbracatura con fondina, nettapiedi e spazzola, e un comodo beauty per trasportare il tutto.
The Avalon clippers are a highly versatile and capable battery operated machine, ideal for use in yards where electricity is not available, or when you wish to take the clippers to the horse.



art. VA00633
1290-0471

Motore / Drive unit	Set di lame professionali / Professional blade set
Velocità di taglio / RPM	Circa / Approx 3.000 rpm
Batteria / Battery	Batteria/ Battery 15-cell 1,7 A
Cavo di connessione / Connecting cable	Cavo a spirale / Spiral cable 1,8 m
Autonomia a batteria carica / Operating time	2,5 - 3 ore / Hours
Dimensioni / Dimensions	185 x 46 x 48 mm
Peso / Weight	Circa / Approx 580 gr. (con lame e cavo) (with blade set and cable)



Umbria
equitazione srl
Official

281

1221-5840 Avalon

MOSER®

art. VA00600

Taglio/Cut 2,3 mm



1854-7351 Adelar

MOSER®

art. VA00598

Taglio/Cut 0.7 - 3 mm



1401-7600 1400

MOSER®

art. VA00619

Taglio/Cut 0,1 - 3 mm



1849-7820 Styling III

MOSER®

art. VA00619A

Taglio/Cut 2,3 mm



1230-7710 Askar

MOSER®

art. VA00597

Taglio/Cut 0,1 - 3 mm



1245-7931 Max45

MOSER®

art. VA00635A

Taglio/Cut 3 mm

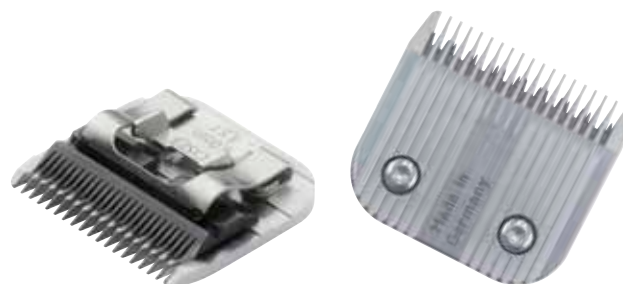

Constanta Rodeo



La tosatrice Constanta Rodeo, con la sua forma ergonomica, mantiene le mani fresche e attive, anche dopo un lungo periodo di tosatura. Leggera, con soli 690 grammi è adatta a tutti i tosatori professionali.

Ergonomically shaped, the constantaRodeo fits perfectly in big and small hands without making them tired! The new developed blades slide smoothly through the coat. Even after long-termed clipping the Rodeo keeps cool and active. Lightweight with only 690 gramms is unique to a professional horse clipper.

art. VA00593
18940



Sistema di taglio / Cutting system	Set di lame professionali / Professional blade set
Alimentazione / Mains voltage	230 V AC 50-60 Hz
Potenza / Motor Output	65 W
Velocità di taglio / Rpm	Circa / Approx 2400 rpm.
Rumorosità / Noise emission	78 dB (A)
Dimensioni / Dimensions	780 x 550 x 240 mm
Peso / Weight	Circa / Approx 690 gr.



Umbria
equitazione srl
Official

Constanta R2 35/24



art. VA00592	18914
Taglio/Cut	Standard



Constanta R22 35/24



art. VA00592A	18916
Taglio/Cut	Fine 0,5 mm



art. VA00608	
Olio per tosatrice/Clipper oil	



VA00609



Scacchiera in plastica per tosatura. Venduta in set da 5 Pz.
Show set. Sold in set of 5 pieces.

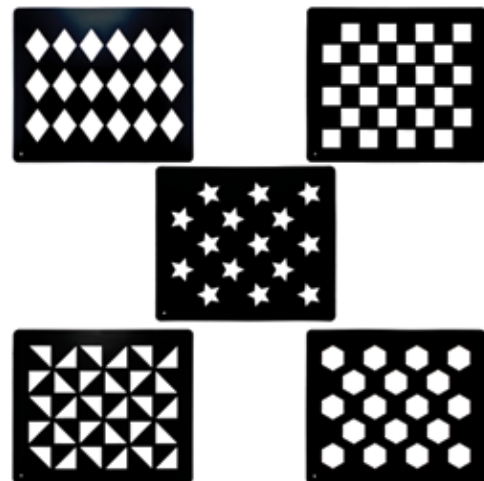

EasyBoot **Original**



EasyCare

Scarpe EasyBoot Original in uretano. Durature, confortevoli, possono sostituire il ferro oppure fornire una protezione aggiuntiva ad esso. Previene la zoppia in caso di perdita di ferri lontano da casa, e sono l'ideale per cavalli con laminite, ascessi e altre patologie relative allo zoccolo. Molto adatte inoltre per ammortizzare gli urti sullo zoccolo nei terreni molto duri. Misure come da tabella. Colore Nero. **Venduta in confezione singola.** Using Easyboots is a natural way to provide hoof protection, traction, cushioning and correction during riding and treatment, while allowing the horse to go barefoot at all other times. They fit snugly to the hoof, are lighter weight, and last many times longer than standard steel shoes. **Sold individually.**



Taglia Size	Larghezza Width	Lunghezza Length
Pony	75-85 mm	85-92 mm
000	86-97 mm	93-105 mm
00	98-110 mm	106-117 mm
0	111-116 mm	118-124 mm
1	117-123 mm	125-130 mm
2	124-130 mm	131-140 mm
3	131-139 mm	141-150 mm
4	140-150 mm	151-163 mm
5	151-163 mm	164-174 mm
6	164-175 mm	175-188 mm
7	176-192 mm	189-195 mm



art. FE00230



Umbria
equitazione srl
Official

www.umbriaequitazione.com

283

EasyBoot **Epic**



EasyCare

Scarpe EasyBoot Epic in uretano. Come la easyboot sostituisce il ferro o ne aggiunge una protezione, previene patologie dello zoccolo e attutisce gli urti sullo stesso. Come tutte le scarpette di questa linea, EasyBoot Epic è particolarmente consigliata per gare di endurance, trekking e completo. Misure come da tabella. Colore Nero. **Venduta in confezione singola.**

The Easyboot Epic has been used by endurance riders in many thousands of miles of competition. These riders have proven that barefoot booted horses can go any distance in every type of terrain, and that the Easyboot Epic can withstand the tests the toughest riders give them. **Sold individually.**



Taglia Size	Larghezza Width	Lunghezza Length
Pony	75-85 mm	85-92 mm
000	86-97 mm	93-105 mm
00	98-110 mm	106-117 mm
0	111-116 mm	118-124 mm
1	117-123 mm	125-130 mm
2	124-130 mm	131-140 mm
3	131-139 mm	141-150 mm
4	140-150 mm	151-163 mm
5	151-163 mm	164-174 mm
6	164-175 mm	175-188 mm
7	176-192 mm	189-195 mm

art. FE00231



EasyBoot **Glove**



EasyCare

Scarpe Easyboot Glove in uretano. Alle stesse proprietà della EasyBoot Epic, si aggiunge una forma ideata per calzare lo zoccolo come un guanto, fornendo protezione senza diminuire la mobilità. Perfette per ogni tipo di terreno, offrono totale stabilità e aderenza al cavallo. Misure come da tabella. Colore Nero. **Venduta in confezione singola.** This form-fitting, seamless boot hugs the hoof and responds like a natural hoof. Flexible and tough, the Glove has an aggressive tread pattern but still allows a free stride and breakover. Like a glove, this boot provides protection without stifling mobility. **Sold individually.**



Taglia Size	Larghezza Width	Lunghezza Length
00	96-99 mm	106-109 mm
00,5	100-103 mm	110-113 mm
0	104-107 mm	114-117 mm
0,5	108-111 mm	118-121 mm
1	112-115 mm	122-125 mm
1,5	116-119 mm	126-129 mm
2	120-123 mm	130-133 mm
2,5	124-127 mm	134-137 mm
3	128-131 mm	138-141 mm
3,5	132-135 mm	142-145 mm
4	136-139 mm	146-149 mm
4,5	140-143 mm	150-153 mm
5	144-147 mm	154-157 mm



art. FE00232

EasyBoot **Old Mac's G2** **EasyCare**

Scarpe EasyBoot Old Mac's G2. La speciale suola high-tech performance incorpora l'esclusivo Hoof™ Suspension System, sviluppato in termo uretano di plastica (TPU), che contribuisce ad accelerare il recupero da infortuni ed a prevenirli. Sono indicate per l'artrite, fratture ossee del pedale, stinchi omogeneizzati, malattia navicolare, fratture al ginocchio, laminite, contusioni alle pareti o soles dello zoccolo. Un uso molto frequente ne viene fatto anche per il trasporto del cavallo sul trailer, queste infatti elimineranno il rischio di scivolate durante l'entrata e l'uscita, facendo sì che il cavallo sia pronto a lavorare quando si arriva a destinazione. Misure come da tabella. Colore Nero. **Vendute in coppia.**

Every Old Mac's G2 horse boot has a unique hi-tech performance outsole and incorporates the patented Hoof Suspension™ System. The Old Mac's G2 is composed of a specially developed Thermo Plastic Urethane (TPU) compound which minimizes concussion and shortens recovery time for horses with concussion-related injuries. The Old Mac's G2 is a great option for pleasure riding (less than 25 miles per week) and can also serve as a therapy boot. If your horse suffers from any of the following - arthritis, pedal bone fractures, navicular disease, ringbone, laminitis (founder), bruised soles, or scalping from overreaching—the Old Mac's G2 horse boot will benefit your horse. **Sold in pairs.**



art. FE00233



Ghette in neoprene incluse
Neoprene gaiters included



di facile applicazione
opens wide for ease of applications

Taglia Size	Larghezza Width	Lunghezza Length
0	100-105 mm	105-110 mm
1	105-110 mm	110-115 mm
2	110-115 mm	115-120 mm
3	115-120 mm	120-125 mm
4	120-125 mm	125-130 mm
5	125-130 mm	130-135 mm
6	130-135 mm	135-140 mm
7	135-140 mm	140-145 mm
8	140-145 mm	145-150 mm
9	145-150 mm	150-155 mm
10	150-155 mm	155-160 mm
11	155-165 mm	160-170 mm
12	165-175 mm	170-180 mm

EasyBoot **Trail** **EasyCare**

Easyboot Trail è la scarpetta più facile da applicare e rimuovere al mondo. Il sistema di aggancio ne assicura la tenuta durante tutto l'utilizzo. La scarpetta si apre completamente per facilitarne l'applicazione e la rimozione nella maggior parte di forme e misure di zoccolo. La parte posteriore con doppia allacciatura in Velcro® protegge l'intera parete dello zoccolo e mantiene la scarpetta salda. Compatibile con le ghette EasyCare. **Venduta in confezione singola.**

The Easyboot Trail is the easiest hoof boot in the world to apply and remove. The attachment system assures booted success throughout the trim cycle. The boot opens up completely to easily slip on and off over most hoof shapes and sizes. The rear double Velcro® attachment protects the entire hoof wall and keeps the boot firmly in place. EasyCare Gaiters are an optional accessory (sold separately). **Sold individually.**

art. FE00236



di facile applicazione
opens wide for a easy application

Taglia Size	Larghezza Width	Lunghezza Length
0	100-105 mm	105-110 mm
1	105-110 mm	110-115 mm
2	110-115 mm	115-120 mm
3	115-120 mm	120-125 mm
4	120-125 mm	125-130 mm
5	125-130 mm	130-135 mm
6	130-135 mm	135-140 mm
7	135-140 mm	140-145 mm
8	140-145 mm	145-150 mm
9	145-150 mm	150-155 mm
10	150-155 mm	155-160 mm
11	155-165 mm	160-170 mm
12	165-175 mm	170-180 mm



Umbria equitazione srl
Official

Simple Hoof Boots



art. FE00210

Scarpa Simple Boot CAVALLO in morbida pelle con interno in neoprene. Ideale per tutti i tipi di terreno ed inoltre per: riabilitazione da infortuni, ascessi, malattie navicolari, laminite, spaccature dello zoccolo. Semplice da indossare e rimuovere, rimane saldamente nello zoccolo. Sagomata, non ha bisogno di inserti o spessori. Resistente all'abrasione, assorbe gli urti e consente l'espansione e la contrazione per favorire la circolazione sanguigna. Impermeabile e suola in TPU. Colore Nero. Misure come da tabella. **Vendute in coppia.**

SIMPLE Boot is a Multi-Purpose Hoof Boot, excellent for: All-terrain hoof protection for the barefoot horse - Comfort for chronic pain or hoof sensitivity - Rehabilitation from injuries, abscesses, navicular disease, laminitis / founder, punctures, sole bruising and contracted heels - Protection during trailering and breeding. **Sold in pairs.**



Umbria equitazione srl
Official



Taglia Size	Larghezza Width
0	102-109 mm
1	110-117 mm
2	118-125 mm
3	126-133 mm
4	134-141 mm
5	142-149 mm
6	150-157 mm

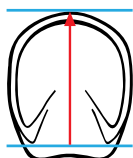

www.umbriaequitazione.com

285

Equine Sports Products

Trek



art. FE00213

Leggera, multiuso, si adatta a tutti i tipi di terreno. Usata per cavalli scalzi come alternativa al ferro, e anche per la riabilitazione di uno zoccolo ferito • Adatto a zoccoli di destra o sinistra • linguetta estraibile per un facile inserimento • sistema brevettato di chiusura a velcro sostituibile • TPU brevettato per una resistenza allo strappo ad elevate prestazioni e resistenza all'abrasione • Disegno ottimizzato per ridurre la resistenza e al minimo il peso. **Vendute in coppia.**

Lightweight, multi-purpose, flexible all-terrain Cavallo Trek horse hoof boot for barefoot horses as an alternative to metal shoes, users who need to replace a lost metal shoe, for rehab of an injured hoof or horses that have odd sized feet. • Fits left or right hooves • Pull tab for easy on • Patented replaceable Velcro closure system • Patented Pro Mesh molded TPU upper for high performance tear strength and abrasion resistance • Honeycomb upper design optimizes strength and minimizes weight. **Sold in pairs.**



Taglia Size	Larghezza Width
0	102-109 mm
1	110-117 mm
2	118-125 mm
3	126-133 mm
4	134-141 mm
5	142-149 mm
6	150-157 mm

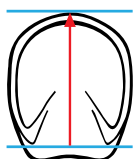

Gel Pad



Suola in gel per scarpe Simple boot e Trek. Aumenta il comfort, la circolazione e assorbe gli urti. Facile da usare, basta tagliarla della misura giusta e inserirla dentro la scarpetta. **Vendute in coppia.**

Made from specially formulated 'Thermoplastic Elastomer'. Removable insole for additional comfort. Simply cut the pattern to your Simple boot size. Insert into boot. One size fits all! **Sold in pairs.**

art. FE00212

Taglia Unica regolabile
One Size Fits



Pastern Wraps



Calza in neoprene con agganci in velcro. Aggiunge protezione alle scarpette Simple Boot o Trek. **Vendute in coppia**

For those who would like additional protection to the Simple Boot or Trek. **Sold in pairs.**

art. FE00211

Taglia Size	Ref.
S	per taglia I for size 0 - 1
M	per taglia I for size 2 - 3
L	per taglia I for size 4 - 6





Taglia Size	Larghezza Width	Lunghezza Length
00	95,25 mm	108 mm
0	114,3 mm	127 mm
1	133,40 mm	142,90 mm
2	142,90 mm	155,60 mm
3	158,80 mm	177,80 mm
4	184,20 mm	196,90 mm
5	203,20 mm	215,90 mm
6	241,80 mm	241,80 mm



Horse Boots

DAVIS
MFG. INC.

Scarpa da medicazione Davis. Ideale per verruche, lacerazioni o altre condizioni aggravate dello zoccolo. Chiusura con velcro regolabile. Misure come da tabella. Colore come catalogo.

Venduta singolarmente.

DAVIS Horse Boots can be used for soaking, poulticing and conditioning. Keep the hoof clean and dry or use the Horse Boot for direct application of medicine to treat abscesses, thrush, puncture wounds and other foot conditions.

Color as a catalogue. **Sold individually.**

art. PR00611

Barrier Boots

DAVIS
MFG. INC.

Scarpa scorta Davis. Ideale per cavalli da gara permette una facile applicazione sul campo senza l'uso di attrezzi. Chiusura con laccio regolabile. Colore nero. **Venduta singolarmente.**

The DAVIS Barrier Boot can be used as a replacement for a lost shoe to keep your horse balanced until the shoe can be replaced. Tough, durable PVC allows the horse to walk unshod, protecting the hoof from cracks and chips. **Sold individually.**

art. PR00610

Taglia Size	Larghezza Width	Lunghezza Length
00	108 mm	114,3 mm
0	114,3 mm	120,7 mm
1	120,7 mm	127 mm
2	133,4 mm	139,7 mm
3	139,7 mm	152,4 mm



Taglia Size	Larghezza Width	Lunghezza Length
XS = 00	108 mm	114,3 mm
S = 0	114,3 mm	120,7 mm
M = 1	120,7 mm	127 mm
L = 2	133,4 mm	139,7 mm
XL = 3	139,7 mm	152,4 mm



Barrier Boots

Umbria
EQUITAZIONE

Scarpa scorta in PVC. Ideale per cavalli da gara permette una facile applicazione sul campo senza l'uso di attrezzi. Chiusura con laccio regolabile. Colore nero. **Venduta singolarmente.**

PVC barrier boot. Ideal for horse racing allows for easy application in the field without the use of tools. Closure with adjustable drawstring. Black color. **Sold individually.**

art. PD00140

art. VA00179

Ciambella per lupia rivestita in gomma. Chiusura regolabile. Vendute singolarmente.

Rubber pattern head rings. Sold individually.



art. VA00173

Ciambella per lupia in gomma. Chiusura regolabile. Vendute singolarmente.

Shoe boil boot. Sold individually.



art. AG00008



Striglia ovale in gomma con punte a spillo in ferro. Misura unica. Colore unico
Grooming comb with metal pins. One size. Various colors.



art. AG00010P



Striglia ovale in gomma Misura Pony. Colori Vari.
Rubber curry comb. Pony size. Various colors.



art. AG00010



Striglia ovale in gomma. Misura grande. Colori Vari.
Rubber curry comb. Large size. Various colors.



art. AG00010A



Striglia ovale sagomata in gomma ergonomica. Misura grande. Colori Vari.
Rubber oval curry comb. Large size. Various colors.



art. AG00009



Striglia tonda in gomma morbida per muso. Misura Unica. Colori Vari.
Rubber soft-touch brush with handle. One size. Various colors.



art. AG00214



Striglia con punte larghe in gomma. Misura Unica. Colore Unico.
Ergonomic rubber groom with wide flexible teeth. One size. Various colors.



art. AG00211



Spazzola tonda per coda e criniera. Misura Unica. Colore Unico.
Ergonomic mane and tail comb. One size. Various colors.



art. AG000211A



Spazzola tonda per coda e criniera con manico. Misura Unica. Colori Vari.
Ergonomic mane and tail comb with handle. One size. Various colors.



Umbria
EQUITAZIONE

art. AG00020

Striglia ovale in plastica dura con passamano. Misura Unica. Colori Vari
Hard plastic oval comb with nylon strap. One size. Various colors.



Umbria
EQUITAZIONE

art. AG00020A

Striglia ovale in plastica morbida con passamano. Misura Unica. Colori Vari
Soft plastic oval comb with nylon strap. One size. Various colors.



Umbria
equitazione srl
Official

Umbria
EQUITAZIONE

art. AG00044

Striglia in plastica con denti flessibili. Misura Unica. Colori Vari.
Plastic massage curry comb with flexible bristles. One size. Various colors.



Umbria
EQUITAZIONE

art. AG00080

Guanto striglia in gomma morbida. Misura Unica. Colori Vari.
Rubber grooming glove pebbled on both sides. One size. Various colors.



Umbria
EQUITAZIONE

art. AG00083

Guanto striglia in tessuto. Misura Unica. Colori Vari.
Double sided "chenille" glove. Various colors.



Umbria
EQUITAZIONE

art. AG00045

Striglia in plastica con attacco per tubo dell'acqua. Misura Unica. Colori Vari.
Plastic washer groomer with hose attachment. One size. Various colors.



Umbria
EQUITAZIONE

art. AG00081

Guanto striglia in gomma con inserto in setole. Misura Unica. Colori Vari.
Rubber dual grooming glove with nylon bristle. One size. Various colors.



Umbria
EQUITAZIONE

art. AG00007

Pietra pomice naturale. Misura Unica. Colore Unico.
Groomer's stone rectangle. One size. Unique color.

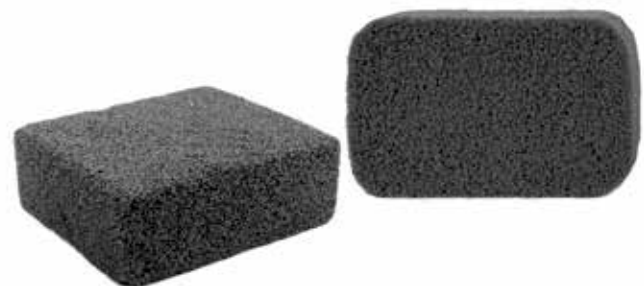

art. AG00030



Striglia ovale in ferro con passamano. Misura Unica. Colore Unico.
Oval metallic curry comb with nylon strap. One size. Unique color.



art. AG00046



Striglia napoletana piatta in ferro con passamano. Misura Unica. Colore Unico.
Square metallic curry comb with nylon strap. One size. Unique color.



290

www.umbriaequitazione.com



Umbria equitazione srl Official

art. AG00046B



Striglia napoletana piatta in ferro artigianale. Misura Unica. Colore Unico.
Rectangular handcraft metallic curry comb. One size. Unique color.



art. AG00046A



Striglia napoletana piatta in alluminio. Misura Unica. Colore Unico.
Rectangular aluminium curry comb. One size. Unique color.



Box & Grooming

art. AG00040



Striglia in ferro a lama tonda con manico. Misura Media.
Round metallic curry comb, reversible medium size.



art. AG00040L



Striglia in ferro a lama tonda con manico. Misura Grande.
Round metallic curry comb, reversible large size.



art. AG00041



Striglia piatta con rastrello e manico in legno. Misura Unica. Colore Unico.
Square metallic curry comb with wooden handle. One size. Unique color.



art. AG00041A



Striglia artigianale con rastrello e manico in legno. Misura Unica. Colore Unico.
Square metallic curry comb with wooden handle. One size. Unique color.



Oster

art. AG00556

Nettapiedi Oster inox con manico in gomma morbida. Misura Unica. Colori: royal blu, rosa.
Stainless steel hoof pick with soft rubber handle. One size. Colors: royal blue, pink.



Oster

art. AG00550

Striglia Oster in gomma morbida con punte. Misura Unica. Colori: royal blu, rosa.
Oster ergonomics rubber groom with wide flexible teeth. One size. Colors: royal blue, pink.



Umbria
equitazione srl
Official

Oster

art. AG00558

Spazzola in gomma Oster per coda e criniera. Misura Unica. Colori: royal blu, rosa.
Oster ergonomics mane and tail comb with handle. One size. Colors: royal blue, pink.



Oster

art. AG00551

Spazzola Oster in gomma con setole alte. Misura Unica. Colori: royal blue, rosa.
Oster dandy brush with synthetic bristles. One size. Colors: royal blu, pink.



AMI-CELL

art. AG00506

Nettapiedi inox con manico in gomma morbida. Misura Unica. Colori: navy blu, bordeaux.
SS hoof pick w/rubber handle and brush. One size. Colors: navy blu, Burgundy.



AMI-CELL

art. AG00505

Pettine doppio per coda e criniera. Colori: navy blu, bordeaux.
Lami-cell mane comb. One size. Colors: navy blu, Burgundy.



AMI-CELL

art. AG00508

Spazzola per coda e criniera. Misura Unica. Colori: navy blu, bordeaux.
Lami-cell mane and tail comb. One size. Colors: navy blu, Burgundy.



AMI-CELL

art. AG00510

Asciugasudore in gomma con manico. Colori: navy blu, bordeaux.
Lami-cell plastic sweat scraper. One size. Colors: navy blu, Burgundy.



art. AG00504



Stiglia in gomma rigida. Misura Unica. Colori: navy blu, bordeaux.
Lami-cell hard plastic curry comb. One size. Colors: navy blu, Burgundy.



art. AG00503



Brusca con passamano e setole rigide. Colori: navy blu, bordeaux.
Lami-cell brush with short hard bristles. Colors: navy blu, Burgundy.



art. AG00509



Brusca con passamano e setole morbide. Colori: navy blu, bordeaux.
Brush with short medium hard bristles. Colors: navy blu, Burgundy.



art. AG00500



Spazzola Lami-Cell in gomma con setole alte. Colori: navy blu, bordeaux.
Lami-cell dandy brush with long bristles. Colors: navy blu, Burgundy.



art. AG00502



Spazzola in gomma con setole basse. Colori: navy blu, bordeaux.
Lami-cell dandy brush with short bristles. Colors: navy blu, Burgundy.



I prodotti sono confezionati
in pratici box espositivi
Products are packed in
display box.

art. AG00507



Grooming box in cordura con scomparti. Colori: navy blu, bordeaux.
Cordura grooming box with compartments. Colors: navy blu, Burgundy.



art. AG00501



Spazzola in gomma con setole medie. Colori: navy blu, bordeaux.
Lami-cell dandy brush with medium bristles. Colors: navy blu, Burgundy.



Umbria
EQUITAZIONE

art. AG00100

Spazzola morbida con dorso in legno. Misura Unica. Colore Unico.
Body brush with wooden handle and nylon strap. One size. Unique color.



Umbria
EQUITAZIONE

art. AG00103

Spazzola morbida con dorso in legno verniciato. Misura Unica. Colore Unico.
Body brush with varnish wooden handle and nylon strap. One size. Unique color.



Umbria
equitazione srl
Official

Umbria
EQUITAZIONE

art. AG00110

Spazzola morbida con dorso in legno. Misura Piccola. Colore Unico.
Finishing brush with wooden handle and leather strap. Small size. Unique color.



Umbria
EQUITAZIONE

art. AG00101

Spazzola morbida con dorso in legno. Misura Media. Colore Unico.
Finishing brush with wooden handle and leather strap. Medium size. Unique color.



Umbria
EQUITAZIONE

art. AG00102

Spazzola morbida con dorso in legno. Misura Grande. Colore Unico.
Finishing brush with wooden handle and leather strap. Big size. Unique color.



Umbria
EQUITAZIONE

art. AG00115

Spazzola morbida setole bilivello dorso in legno. Misura Unica. Colore Unico.
Two-level finishing brush with wooden handle and leather strap. Unique color.



Umbria
EQUITAZIONE

art. AG00099

Spazzola con setole in rame e dorso in legno. Misura Unica. Colore Unico.
Body brush with brass wire with outside circle PVC bristle. One size.



Umbria
EQUITAZIONE

art. AG00118

Spazzole morbida con setole corte e dorso in legno. Misura Unica. Colore Unico.
Soft brush with wooden handle and leather strap. One size. Unique color.



art. AG00116



Spazzola "Scotland" con setole morbide in legno. Misura Unica. Colori Unici.
Finishing brush type "Scotland" with wooden handle. One size. Unique colors.



art. AG00109



Spazzola morbida con dorso in plastica morbida. Misura Unica. Colori Unici.
Body brush with soft plastic handle. One size. Unique colors.



art. AG00106



Spazzola con setole morbide e dorso in legno. Misura Unica. Colore Unico.
Finishing brush with ultra-soft bristles, wooden handle. One size. Unique color.



art. AG00119



Spazzola morbida rettangolare con setole naturali. Misura Pony. Colore Unico.
Body brush with wooden handle. Small size. Unique color.



art. AG00107B



Spazzola con setole morbide, rettangolare. Misura Pony. Colore Unico.
Finishing brush with ultra-soft bristles. Small size. Unique color.



art. AG00107



Spazzola con setole morbide bicolore. Misura Pony. Colori Vari
Two-tone body brush with wooden handle. Small size. Unique color.



art. AG00309A



Spazzola con setole morbide fantasia "Horse". Misura Pony. Colori Vari
Body brush type "Horse" with wooden handle. Small size. Unique color.



art. AG00200A



Grooming set completo a zainetto. Colori Vari.
Grooming set with plastic backpack. Various colors.



Grooming set completo a zainetto gonfiabile. Colori: rosa, celeste, viola.
Grooming set with plastic inflatable backpack. Colors: pink, baby blu, violet.



art. AG00318

Grooming kit Leistner completo. Colori vari.
Leistner grooming set. Various colors.



art. AG00316

Spazzola Leistner con setole morbide "Reflex". Misura Pony. Colori Vari.
Leistner finishing brush "Reflex" with soft bristles. Small size. Various colors.



art. AG00309

Spazzola Leistner con setole extra morbide. Misura Pony. Colori Vari.
Leistner finishing brush with ultra-soft bristles. Small size. Various colors.



Grooming set completo. Colori: navy blu, viola, rosa, marrone, lime, celeste.
Grooming set with bag. Colors: navy blu, violet, pink, brown, lime, sky blue.



art. AG00321

Spazzola Leistner con setole morbide "Ribbon". Misura Pony. Colori Vari.
Leistner finishing brush "Ribbon" with soft bristles. Small size. Various colors.



art. AG00315

Spazzola Leistner con setole morbide "Horse". Misura Pony. Colori Vari.
Leistner finishing brush "Horse" with soft bristles. Small size. Various colors.



art. AG00306

Spazzola Leistner con setole morbide e dorso legno. Misura Pony. Colori Vari.
Leistner finishing brush with soft bristles. Small size. Various colors.



art. AG00329

Brusca Leistner dorso legno con setole naturali. Misura Unica. Colore Unico.
Leistner body brush with natural bristles. One size. Unique color.



art. AG00304

Spazzola Leistner setole morbide "Grand Gilbert". Misura Unica. Colore Unico.
Leistner body brush with soft bristles "Grand Gilbert". One size. Unique color.



art. AG00305

Spazzola Leistner con setole morbide "Holly". Misura Unica. Colore Unico.
Leistner body brush with soft bristles "Holly". One size. Unique color.



art. AG00302

Spazzola Leistner con setole Ultra Soft "Arabian". Misura Unica. Colore Unico.
Leistner body brush with ultra-soft bristles "Arabian". One size. Unique color.



art. AG00324

Spazzola Leistner con setole sintetiche. Misura Unica. Colore Unico.
Leistner body brush with synthetic bristles. One size. Unique color.



art. AG00301

Spazzola Leistner con setole naturali "Pik Konig". Misura Unica. Colore Unico.
Leistner body brush with natural bristles "Pik Konig". One size. Unique color.



art. AG00300

Spazzola Leistner con setole bilivello "Gigolo". Misura Unica. Colore Unico.
Leistner body brush with two-level bristles "Gigolo". One size. Unique color.



art. AG00329A

Spazzola Leistner setole bilivello passamano Basket. Misura Unica. Colore Unico.
Leistner body brush with two-level bristles "Basket". One size. Unique color.





art. AG00313

Spazzola Leistner con setole in rame. Misura Unica. Colore Unico.
Leistner body brush with brass and PVC bristles. One size. Unique color.



art. AG00049

Striglia in plastica modello "Magic". Set di 3 pezzi.
Plastic ergonomic curry comb "Magic". 3 pcs set.



Umbria
equitazione srl
Official



art. AG00325

Spazzola lava zoccoli Leistner con setole alte. Misura Unica. Colori Vari.
Leistner dandy brush with long bristles. One size. Various colors.



art. AG00317

Spazzola lava zoccoli Leistner con setole naturali. Misura Unica. Colore Unico.
Leistner dandy brush with long natural bristles. One size. Unique color.



art. AG00326

Spazzola sagomata Leistner con setole naturali. Misura Unica. Colore Unico.
Leistner ergonomic brush with two-level natural bristles. One size. Unique color.



art. AG00105

Spazzola lava zoccoli con setole naturali. Misura Unica. Colore Unico.
Leistner dandy brush with short natural bristles. One size. Unique color.



art. AG00112A

Spazzola lava zoccoli con setole basse. Misura Unica. Colori Vari.
Dandy brush with short nylon bristles. One size. Various color.



art. AG00112

Spazzola lava zoccoli con setole alte. Misura Unica. Colori Vari.
Dandy brush with long nylon bristles. One size. Various color.



art. AG00113



Spazzola lava zoccoli con nettapiedi. Misura Unica. Colori Vari.
Body brush with wooden handle and hoof pick. One size. Various colors.



art. AG00450



Spazzola lava zoccoli in legno con manico. Misura Unica. Colori Vari.
Wooden hoof brush with handle. One size. Various color.



298

www.umbriaequitazione.com

art. LE00121



Spazzola lava zoccoli Effol in legno con manico. Misura Unica. Colore unico.
Effol wooden hoof brush with handle. One size. Unique color.



art. AG00114



Spazzolino in legno con manico. Misura Unica. Colore unico.
Hoof dressing brush with brass and PVC bristles. One size. Unique color.



Box & Grooming

art. AG00098



Spazzola per coda e criniera con spilli in metallo e manico. Colore Unico.
Wooden mane and tail brush with handle and metal pins. One color.



art. AG00303



Spazzola Leistner per coda e criniera con spilli in metallo e manico. Colore Unico.
Leistner wooden mane and tail brush with handle and metal pins. One color.



art. AG00108



Spazzola per coda e criniera con spilli in metallo. Colore Unico.
Wooden mane and tail brush with metal pins. One color.



art. AG00314



Spazzola Leistner per coda e criniera con spilli in metallo. Misura Unica.
Leistner wooden mane and tail brush with metal pins. One color.



Umbria equitazione srl Official

Umbria
EQUITAZIONE

art. AG00093

Brusca con setole sintetiche corte e dorso in plastica. Misura Unica. Colori Vari.
Body brush with short synthetic bristles and plastic handle. Various colors.



Umbria
EQUITAZIONE

art. AG00094

Brusca con setole sintetiche medie e dorso in plastica. Misura Unica. Colori Vari.
Body brush with medium synthetic bristles and plastic handle. Various colors.



Umbria
equitazione srl
Official

Umbria
EQUITAZIONE

art. AG00089

Brusca con setole sintetiche alte e dorso in plastica. Misura Unica. Colori Vari.
Body brush with long synthetic bristles and plastic handle. Various colors.



Umbria
EQUITAZIONE

art. AG00090

Bruscone con setole sintetiche. Misura Unica. Colore Unico.
Body brush with synthetic bristles and plastic handle. Unique color.



Umbria
EQUITAZIONE

art. AG00090A

Bruscone con setole sintetiche e dorso in legno. Misura Unica. Colori Vari.
Body brush with synthetic bristles and wooden handle. Various colors.



Umbria
EQUITAZIONE

art. AG00092

Bruscone con setole naturali e dorso in legno. Misura Unica. Colore Unico.
Body brush with short natural bristles and wooden handle. Unique color.



Umbria
EQUITAZIONE

art. AG00091

Bruscone con setole sintetiche dorso in vernice. Misura Unica. Colori Vari.
Body brush with synthetic bristles and wooden laquered handle. Various colors.



Umbria
EQUITAZIONE

art. AG00104

Spazzola con setole sintetiche ed impugnatura. Misura Unica. Colore Unico.
Body brush with short synthetic bristles and plastic handle. Unique color.



www.umbriaequitazione.com

299

Box & Grooming

art. AG00060 **Umbria**
EQUITAZIONE
Nettapiedi in plastica con gancio e spazzolino.
Colori Vari.
Plastic hoof pick with brush. Various colors.



art. AG00060G **Umbria**
EQUITAZIONE
Nettapiedi in plastica manico gomma con
gancio e spazzolino. Colori Vari.
Plastic rubber covered hoof pick with brush.
Various colors.



art. AG00060A **Umbria**
EQUITAZIONE
Nettapiedi in plastica con gancio e spazzolino.
Colori Vari.
Plastic hoof pick with brush. Various colors.



art. AG00062 **Umbria**
EQUITAZIONE
Nettapiedi in plastica con testa di cavallo,
gancio e spazzolino. Colori Vari.
Horse head plastic hoof pick with brush.
Various colors.



art. AG00061 **Umbria**
EQUITAZIONE
Nettapiedi in plastica con gancio, spatola e
spazzolino. Colori Vari.
Plastic hoof pick with brush and scraper.
Various colors.



art. AG00063 **Umbria**
EQUITAZIONE
Nettapiedi in plastica con gancio e manico in
gomma. Colori Vari.
Plastic hoof pick with soft rubber handle.
Various colors.



art. AG00506 **AMI-CELL**
Nettapiedi Lami-Cell in gomma morbida. Misu-
ra Unica. Colori: Blu e Bordeaux.
Lami-cell hoof pick with brush. One size. Co-
lors: Navy blu, Burgundy.



art. AG00556 **Oster**
Nettapiedi in plastica Oster con gancio e mani-
co in gomma. Colori: Rosa e Blu.
Oster hoof pick with soft rubber handle. One
size. Colors: Navy blu, Pink.



art. AG00051 **Umbria**
EQUITAZIONE
Nettapiedi con impugnatura in plastica con
gancio. Colori Vari.
Deluxe hoof pick with plastic handle. Various
colors.



art. AG00050 **Umbria**
EQUITAZIONE
Nettapiedi con manico plastificato gommato a
goccia. Colori Vari.
Hoof pick with rubber covered handle.
Various colors.



art. AG00052 **Umbria**
EQUITAZIONE
Nettapiedi in plastica con gancio e manico in gomma con led. Colori Vari.
Hoof pick with plastic handle and led. Various colors.

LED



art. AG00125

Pennello con setole morbide e cappuccio in plastica. Misura Unica. Colori Vari. Disponibile in confezione da 24 pz. assortiti art. **AG00125S**.

Plastic hoof dressing brush with cap. One size. Various colors. Available also in 24 pieces color assorted box. art. **AG00125S**.



art. AG00319

Pennello Leistner con setole naturali e manico in legno, completo di porta pennello. Misura Unica. Colore Unico.

Hoof dressing brush dust-proof with wooden handle and natural bristles. One size. Unique color.



art. AG00307

Pennello Leistner con setole naturali e manico in legno. Misura Unica. Colore Unico.

Leistner wooden hoof dressing brush with natural bristles. One size. Unique color.



art. AG00123

Pennello in plastica completo di porta pennello. Misura Unica. Colore Unico. Hoof dressing brush dust-proof with plastic handle. One size. Unique color.



art. AG00122

Pennello con setole rigide e manico in legno Misura Unica. Colore Unico. Wooden hoof dressing brush. One size. Unique color.



art. AG00308

Pennello Leistner con setole naturali e manico in legno verniciato. Misura Unica. Colori Vari.

Leistner laquered wooden hoof dressing brush with natural bristles. One size. Various colors.



art. AG00120

Pennello con setole morbide. Misura Unica. Colori Vari. Plastic hoof dressing brush. One size. Various colors.



art. AG00172

Umbria
EQUITAZIONE

Forbice per criniera a punta curva con manico in plastica Misura Unica. Colore Unico.
Scissors with curved blade and plastic handle. One size. Unique color.



art. AG00175

Umbria
EQUITAZIONE

Forbice pr taglio di fasce adesive. Misura Unica. Colore Unico.
Scissors for adhesive bandages with plastic handle. One size. Unique color.



art. AG00173

Umbria
EQUITAZIONE

Forbice sfolti criniera con manico in plastica Misura Unica. Colore Unico.
Thinning scissors with plastic handle. One size. Unique color.



art. AG00171

Umbria
EQUITAZIONE

Forbice sfolti criniera in acciaio. Misura Unica.
Thinning scissors. One size. Stainless steel.



art. AG00176

Umbria
EQUITAZIONE

Forbice per criniera a punta curva in acciaio. Misura Unica.
Scissors with curved blade. One size. Stainless steel.



art. AG00170

Umbria
EQUITAZIONE

Coltello pieghevole sfolti criniera con manico in legno. Misura Unica. Colore Unico.
Folding mane stripping comb with wooden handle. One size. Unique color.



art. VA00175A

Umbria
EQUITAZIONE

Coltello multifunzione da viaggio. Misura Unica. Colore Unico.
Combination hoof care folding knife (6 in one).



art. VA00185

Umbria
EQUITAZIONE

Set da trekking tascabile con manico in plastica. Misura Unica. Colore Unico.
Multi-function hand tool 9 in one with plastic covered handle. One size. Unique color.



art. VA00184

Umbria
EQUITAZIONE

Set da trekking tascabile in acciaio. Misura Unica. Colore Unico.
Multi-function hand tool 9 in one. One size. Unique color.



art. VA00175B

Umbria
EQUITAZIONE

Coltello da trekking tascabile con curasnetta. Misura Unica. Colore Unico.
Trekking knife with hoof pick. One size. Unique color.



art. VA00188

Elk Ridge

Coltello Elk Ridge tascabile da trekking. Misura Unica. Colore Unico.
Elk Ridge trekking knife. One size. Unique color.



art. VA00189

Elk Ridge

Coltello Elk Ridge tascabile multilama con contenitore. Misura Unica. Colore Unico.
Elk Ridge trekking multi-knife. One size. Unique color.



Umbria
EQUITAZIONE

art. AG00144

Pettine in alluminio con manico in legno. Misura Unica.
Mane and tail comb with wooden handle. One size.



Umbria
EQUITAZIONE

art. AG00141

Pettine grande in alluminio con manico. Misura Unica.
Mane and tail comb with handle. One size.



Umbria
EQUITAZIONE

art. AG00140

Pettine in alluminio con curasnetta. Misura Unica.
Mane and tail comb with hoof pick handle. One size.



Umbria
EQUITAZIONE

art. AG00146

Pettine rasoio per coda e criniera in plastica. Misura Unica.
Plastic thinning comb. One size.



Umbria
equitazione srl
Official

Umbria
EQUITAZIONE

art. AG00131

Pettine piccolo in alluminio. Misura Unica.
Mane and tail comb. One size.



Umbria
EQUITAZIONE

art. AG00130

Pettine a rastrello in ferro. Misura Unica.
Curling comb with wooden handle. One size.



Umbria
EQUITAZIONE

art. AG00143

Pettine in alluminio con testa di cavallo. Misura Unica.
Horse head aluminium mane and tail comb. One size.



Umbria
EQUITAZIONE

art. AG00142

Pettine per cavallo in alluminio. Misura Unica.
Aluminium mane and tail comb. One size.



Umbria
EQUITAZIONE

art. AG00150

Elastici per criniera. Colori: bianco, nero, marrone, rosso.
Braiding bands. One size. Colors: white, black, brown, red.



Umbria
EQUITAZIONE

art. AG00151A

Elastici per criniera in barattolo. Colori: bianco, nero, marrone, rosso.
Braiding bands in box. One size. Colors: white, black, brown, red.



Umbria
EQUITAZIONE

art. AG00153

Elastici per criniera in silicogel. Misura Unica. Colori Vari.
Silicone bands. Various colors.



Umbria
EQUITAZIONE

art. AG00154

Elastici per criniera Rainbow. Colore unico.
Braiding bands "Rainbow". Unique color.



Umbria
EQUITAZIONE

art. AG00155

Elastici per criniera "Crystal" confezione da 20 pz. Misura: diametro 1,5 cm.
Crystal braided ring sold in bag of 20 pieces. Size: 1,5 cm diameter.



Effol[®]

art. LE00101

Elastici per criniera trasparenti Effol in sacchetto. Colore: nero, trasparente
Effol transparent braiding bands. Color: black, transparent.



Effol[®]

art. LE00102

Elastici per criniera multicolor Effol in sacchetto. Colori Mix.
Effol multicolor braiding bands. Mix colors.



Umbria
EQUITAZIONE

art. AG00152

Fiocchetti per criniera. Misura Unica. Colori Vari
Braiding bands with textile ribbon. Various color.



art. AG00160

Umbria
EQUITAZIONE

Spugna rettangolare. Misura grande. Colori Vari.
Rectangular sponge. Size large. Various colors.



art. AG00070

Umbria
EQUITAZIONE

Stecca asciuga sudore liscia. Misura Unica.
Colore Unico.
Metal smooth blade sweat scraper. One size.
Unique color.



art. AG00072

Umbria
EQUITAZIONE

Asciuga sudore curvo con manico in plastica.
Misura Unica. Colori Vari.
Plastic curved sweat scraper with handle. One
size. Various colors.



art. AG00161

Umbria
EQUITAZIONE

Spugna rettangolare. Misura piccola. Colori Vari.
Rectangular sponge. Size small. Various colors.



art. AG00069

Umbria
EQUITAZIONE

Stecca asciuga sudore dentata. Misura Unica.
Colore Unico.
Metal smooth and serrated blade sweat scraper. One size. Unique color.



art. AG00071

Umbria
EQUITAZIONE

Asciuga sudore curvo con manico in legno.
Misura Unica. Colore unico.
Metal curved sweat scraper with wooden
handle. One size. Various colors.



art. AG00162

Umbria
EQUITAZIONE

Spugna rettangolare con striglia in gomma.
Misura Unica. Colori Vari.
Rectangular sponge with rubber curry comb.
One size. Various colors.



art. AG00070A

Umbria
EQUITAZIONE

Stecca asciuga sudore liscia grande. Misura
Unica. Colore Unico.
Metal smooth blade sweat scraper with wide
blade. One size. Unique color.



art. AG00068

Umbria
EQUITAZIONE

Stecca asciuga sudore in plastica. Misura
Unica. Colori Vari.
Plastic sweat scraper. One size. Various colors.



art. AG00163

Umbria
EQUITAZIONE

Spugna rettangolare grande con dorso in goma
tipo striglia. Misura Unica. Colore Unico.
Rectangular sponge with rubber sweat scraper.
One size. Various colors.



Bauletto porta accessori piccolo con vaschetta interna. Portata 100 kg. Dimensioni: h 25 x l 40 x w 22. Colori: Midnight Blue, Candy Pink Purple, Ocean Blue Sky, Raspberry Blue. Grooming box with tray. 100 kg carrying capacity. External dimensions: h 25 x l 40 x p 22. Colori: Midnight Blue, Candy Pink Purple, Ocean Blue Sky, Raspberry Blue.

Raspberry Blue

Ocean Blue Sky



Candy Pink Purple

Midnight Blue



Umbria
equitazione srl
Official

Carrello porta accessori da groom in ferro a due ruote. Misura Unica. Colore Unico. Metal basket push cart for grooming accessories with wheels. One size. Unique color. art. VA00913

Bauletto porta accessori piccolo per bambini con vaschetta interna. Dimensioni h 18 x l 40 x p 20. Misura Unica. Colori: Ocean Blue, Candy Pink. Grooming box with tray. External dimensions: h 18 x l 40 x w 20. Colors: Ocean Blue, Candy Pink.

Candy Pink



Ocean Blue

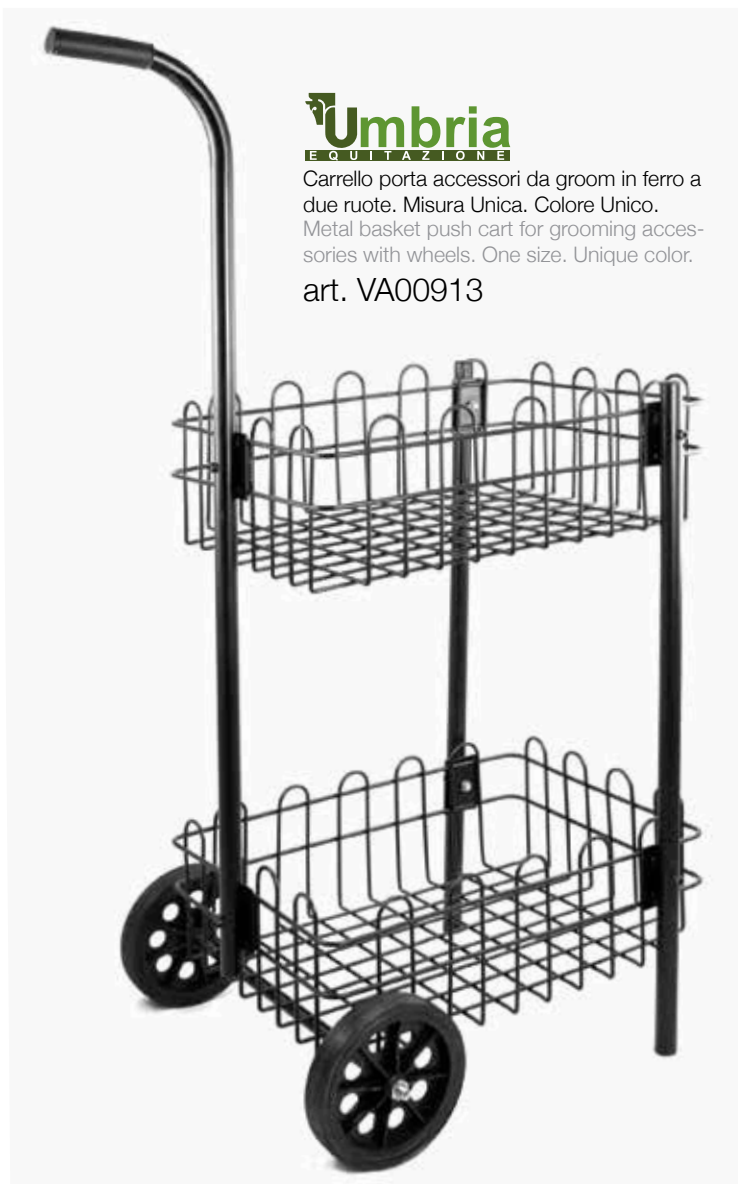

art. VA00022

Bauletto porta accessori piccolo con vaschetta interna e rinforzo per sedile.
Dimensioni: h 25 x l 40 x p 22. Misura Unica. Colori: *Black Fuchsia*,
Black Pistachio, *Lilac Purple*.

Grooming box with tray. Possibility to use like a seat External dimensions:
h 25 x l 40 x w 22. Colors: *Black Fuchsia*, *Black Pistachio*, *Lilac Purple*.

Black Fuchsia



Lilac Purple



Black Pistachio



306

www.umbriaequitazione.com

Protezioni - Protections



Umbria
equitazione srl
Official

art. VA00023

Bauletto porta accessori piccolo con vaschetta interna, porta frustino e
vaschette esterne. Dimensioni: h 25 x l 40 x p 22. Misura Unica. Colori:
Sky Blu, *Violet*, *Burgundy*.

Grooming box with tray. External dimensions: h 25 x l 40 x w 22. Colors:
Sky Blu, *Violet*, *Burgundy*.

Sky Blu



Violet



Burgundy



Umbria
EQUITAZIONE

art. VA00016

Bauletto porta accessori alto con doppia vaschetta interna. Dimensioni: h 32 x l 41 x p 29. Misura Unica. Colori: *Pearl Midnight Blu, Lilac Purple*.
Grooming box with tray. External dimensions: h 32 x l 41 x w 29. Colors: *Pearl Midnight Blu, Lilac Purple*.

Lilac Purple



Pearl Midnight Blu



Umbria
equitazione srl
Official

www.umbriaequitazione.com

307

Box & Grooming

Umbria
EQUITAZIONE

art. VA00019

Bauletto porta accessori grande con doppia vaschetta interna e rinforzi per sedile. Dimensioni: h 36 x l 56 x p 28. Misura Unica. Colori: *Green Tobacco, Red Khaki, Blue Midnight*.

Grooming box with tray. Possibility to use like a seat. External dimensions: h 36 x l 56 x w 28. Colors: *Green Tobacco, Red Khaki, Blue Midnight*.

Green Tobacco



Red Khaki



Blue Midnight





308

www.umbriaequitazione.com

Box & Grooming



art. VA00013

Baule da viaggio con ruote, scomparti interni, coperchio con vaschetta porta oggetti. Dimensioni h 42 x l 68 x p 38. Misura Unica. Colori: Black-Red.

Saddle carrying case with wheels and lid compartments to store small accessories. External dimensions: h 42 x l 68 x w 38. Colors: Black-Red.

Umbria
EQUITAZIONE



Umbria
equitazione srl
Official



art. VA00011

Baule grande da viaggio porta sella con ruote e coperchio porta oggetti. Dimensioni h 49 x l 75 x p 48. Misura Unica. Colori: Black-Red.

Saddle carrying case with wheels and lid compartments to store also an english saddle. External dimensions: h 49 x l 75 x w 48. Colors: Black-Red.

Umbria
EQUITAZIONE

art. VA00030

Mangiatoia in plastica con staffe in metallo. Misura Unica. Colori: Rosso, Royal, Verde, Nero.

Utility feeder with attaching hooks to be fixed on doors or fence. One size. Colors: red, royal blue, green, black.



art. VA00035

Mangiatoia in plastica con manico e staffe in metallo. Misura Unica. Colori: Rosso, Royal, Verde, Nero.

Utility feeder with handle and attaching hooks to be fixed on doors or fence. One size. Colors: red, royal blue, green, black.



Umbria
equitazione srl
Official

309

Box & Grooming

art. VA00036

Mangiatoia in plastica antiurto con manico e staffe in plastica resistente ABS. Misura Unica. Colori: Rosso, Royal, Verde, Nero, Rosa.

Utility feeder with plastic handle and plastic attaching hooks to be fixed on doors or fence. One size. Colors: red, royal blue, green, black, pink.



art. VA00029

Mangiatoia quadrata in plastica con ganci e maniglia. Misura Unica. Colore: verde

Utility feeder with plastic handle and plastic attaching hooks to be fixed on doors or fence. One size. Color: green.



art. VA00042

Mangiatoia rettangolare in gomma antiurto. Misura Unica. Colore Unico.

Rubber wall feeder. One size. Unique color.



art. VA00031

Mangiatoia in plastica tonda da pneumatico. Misura Unica. Colore Unico.

N.B. Pneumatico non incluso.

Plastic field manger/drinking bowl. One size. Unique color. Pneumatic is not included.



art. VA00041

KERBL

Mangiatoia da muro in plastica resistente ABS, in forma rettangolare antispreco. Dimensioni: h 30 x l 32 x p 42. Contenuto: ca 15 litri. Colore Unico.
Shatter-proof plastic feed trough with feed saver. External dimensions: w 42 x h 30 x l 32. Content approx. 15 litres. Unique color.



art. VA00047

KERBL

Mangiatoia in ferro zincato, rettangolare con barre antispreco. Misura Unica. Colore Unico. Dimensioni: h 45 x l 34 x p 23.
Galvanized feed trough with protection against injuries. External dimensions: w 45 x h 34 x l 23. Content approx. 35 litres. Unique color.



Umbria
equitazione srl
Official

art. VA00040

Umbria
EQUITAZIONE

Mangiatoia angolare in plastica con bordo in ferro e tappo sul fondo per pulizia. Misura Unica. Colore Unico. Capacità: circa 19 litri.
Plastic corner manger with galvanized edge. Easy to clean thanks to its draining plug. One size. Unique color. Capacity: approx 19 litres.



art. VA00040A
Vasca sostitutiva in plastica per art. VA00040.
Plastic replacement for manger art. VA00040.

art. VA00045

Umbria
EQUITAZIONE

Mangiatoia angolare in plastica con bordo in ferro, grate antispreco e tappo sul fondo per pulizia. Misura Unica. Colore Unico. Capacità: circa 19 litri.
Plastic corner manger with galvanized edge and with bars. Easy to clean thanks to its draining plug. One size. Unique color. Capacity: approx 19 litres.



art. VA00032

Umbria
EQUITAZIONE

Mangiatoia tonda removibile in plastica con bordo zincato anti spreco e con piastra per attacco. Capacità: 17 litri. Colore Unico.
Mobile feeding trough with aluminium border and galvanized iron support. Capacity 17 litres. Unique color.

**KERBL**

art. VA00048

Mangiatoia tonda in alluminio da parete con protezione anti urto. Circonferenza: 35cm. Capacità: 18l.
Aluminium feed trough with support structure. Circumference: 35 cm. Capacity: 18 litres.

**KERBL**

art. VA00049

Mangiatoia angolare tonda in alluminio da parete con protezione anti urto. Misura Unica.
Aluminium feed trough with corner support. Circumference: 35 cm. Capacity: 18 litres.



Umbria
EQUITAZIONE

art. VA00033

Mangiatoia per puledri in plastica resistente ABS con grate regolabili salva mangime e tappo. Dimensioni: p 33 x h 33,5 x l 28 . Colore Unico.

Shatter-proof plastic foal trough with iron bars and drain plug. Dimensions: w 33 x h 33,5 x d 28. Unique color.



Umbria
equitazione srl
Official

Umbria
EQUITAZIONE

art. VA00810

Secchio in plastica resistente con manico. Circonferenza 40cm, altezza 27cm, capacità 18 litri. Colori: Royal, Nero, Verde, Rosso.

Plastic bucket with handle. Dimensions: circumference 40 cm x h 27 cm, capacity 18 litres. Colors: royal blue, black, green, red.



Umbria
EQUITAZIONE

art. VA00809

Secchio con manico in plastica robusta anti urto da parete. Misura Unica. Colori: Royal, Nero, Verde, Rosso.

Plastic feed and water bucket with handle. Capacity 20 litres. Colors: royal blue, black, green, red.



Umbria
EQUITAZIONE

art. VA00807

Secchio in gomma morbida antiurto con manico. Capacità 18 Lt. Colore Nero.

Rubber feed and water bucket with handle. Capacity 18 litres. Unique color.



Umbria
EQUITAZIONE

art. VA00806

Secchio da 35 Lt. in plastica flessibile con manici. Colori Vari.

Flexible 35 Lt. bucket with handles. Various colors.



Umbria
EQUITAZIONE

art. VA00034

Sacca abbeveratoio portatile in plastica resistente. Misura Unica. Colori: rosso, nero, royal blu.

Collapsible travel bucket in coated canvas. One size. Colors: red, black, royal blue.



art. VA00161 **Umbria**
EQUITAZIONE
Sacca portatile per mangime e fieno in cordura. Misura Unica. Colori Vari.
Canvas feed bag with venting holes. One size. Various colors.



art. VA00372 **Umbria**
EQUITAZIONE
Sacca porta fieno in cordura. Misura Unica. Colore Unico.
Canvas hay bag with hanging rings. One size. Unique color.



art. VA00371 **Umbria**
EQUITAZIONE
Rete per fieno in nylon a maglia grande. Misura Unica. Colori Vari.
Nylon hay net with wide mesh. One size. Various colors.



art. VA00370 **Umbria**
EQUITAZIONE
Rete per fieno in nylon a maglia piccola. Misura Unica. Colori Vari.
Nylon hay net with tight mesh. One size. Various colors.



art. VA00960 **Umbria**
EQUITAZIONE
Portafieno da muro in ferro zincato ripiegabile a muro. Misura Unica. Colore Unico.
Galvanized foldable wall hay rack. One size. Unique color.



art. VA00960A **Umbria**
EQUITAZIONE
Portafieno da muro angolare in ferro zincato. Misura Unica. Colore Unico.
Galvanized corner hay rack. One size. Unique color.



art. VA00020 **Umbria**
EQUITAZIONE
Sessola in plastica per mangime. Misura Unica. Colore Unico. Capacità 1,6 kg.
Plastic feeding scoop. One size. Unique color. Capacity: 1,6 kg.



art. VA00021 **Umbria**
EQUITAZIONE
Sessola in plastica per mangime, grande. Misura Unica. Colori Vari. Capacità 2 kg.
Plastic feeding scoop. One size. Various color. Capacity: 2 kg.



art. VA00021A **Umbria**
EQUITAZIONE
Sessola in alluminio per mangime. Misura Unica. Colore unico. Capacità 1,6 kg.
Aluminium feeding scoop. One size. Unique color. Capacity: 1,6 kg.



Umbria
EQUITAZIONE

art. VA00067

Abbeveratoio in plastica a livello costante con tappo per pulizia. Capacità: 3 litri. Colore: verde.
Constant water level drinking bowl with float valve and plug. Capacity: 3 litres. Color: green.



Umbria
EQUITAZIONE

art. VA00070

Abbeveratoio in plastica a livello costante con piastra in acciaio e tappo per pulizia. Misura Unica. Colore: verde.
Constant water level drinking bowl with float valve and SS cover. One size. Color: green.



Umbria
EQUITAZIONE

art. VA00060

Abbeveratoio in plastica ABS a livello costante con piastra in acciaio e tappo per pulizia. Misura Unica. Colore: blu navy.
Constant water level drinking bowl with float valve and plug. Capacity: 6 litres. Color: navy.



Umbria
equitazione srl
Official

www.umbriaequitazione.com

313

Box & Grooming

Umbria
EQUITAZIONE

art. VA00065

Abbeveratoio in ferro zincato a livello costante. Attacco in ottone. Capacità: 3 litri.
Galvanized constant water level drinking bowl with float valve and plug. Capacity: 3 litres.



Umbria
EQUITAZIONE

art. VA00061

Abbeveratoio in ghisa a livello costante con tappo per pulizia. Capacità: 6 lt. Colore: blu navy.
Cast iron constant water level drinking bowl with float valve and plug. Capacity: 6 litres.



Umbria
EQUITAZIONE

art. VA00062

Abbeveratoio automatico a pressione in plastica resistente. Misura Unica. Colore: royal blu.
Large water bowl made of high-quality plastic. One size. Color: royal blue.



Umbria
EQUITAZIONE

art. VA00063A

Abbeveratoio automatico a pressione in ghisa. Capacità: 1,45 litri. Colore: nero.
Water bowl made of gray cast iron with stainless steel nose paddle. Capacity: 1,45 litres.



Umbria
EQUITAZIONE

art. VA00063

Abbeveratoio automatico a pressione in ghisa "high quality". Misura Unica. Colore: blu navy.
Water bowl made of "high quality" cast iron. One size. Color: navy.



KERBL

art. VA00071

Abbeveratoio automatico in acciaio con valvola per tubo. Ø 27 cm, capacità: 5 litri. Colore Unico.
Stainless steel water bowl with tube valve. Ø 27 cm, capacity: 5 litres. Unique color.



art. VA00160



Museruola in plastica con griglia frontale. Misura Unica. Colore Unico.
Plastic muzzle with grid and nylon straps. One size. Unique color.



art. VA00160A



Museruola in plastica con fori. Misura Unica. Colore Unico.
Plastic muzzle with holes and nylon straps. One size. Unique color.



art. VA00160C



Museruola in nylon e neoprene. Misure: Pony, Cob, Full. Colore Unico.
Nylon and neoprene muzzle with halter. Size: Pony, Cob, Full. Unique color.



art. VA00160B



Museruola in nylon con griglia inox frontale. Misura Unica. Colore Unico.
Nylon muzzle with stainless steel grid and nylon straps. One size. Unique color.



art. VA00162



Museruola in cuoio con parte frontale in acciaio. Misura Unica. Colore Unico.
Leather muzzle with holes and leather straps. One size. Unique color.



art. SB9000



Museruola in cuoio Schutz Brothers. Misura Unica. Colore Unico.
Schutz Brothers leather muzzle. One size. Unique color.



art. VA00159



Bavetta in plastica anti morso. Misura Unica. Colore Unico.
Plastic bib with nylon straps. One size. Unique color.



art. VA00159A



Bavetta in neoprene anti morso. Misura Unica. Colore Unico.
Neoprene bib with nylon straps. One size. Unique color.



Forca da scuderia in plastica resistente. Misura Unica.

Plastic fork. One size.

Colori/Colors

- black 001
- red 003
- royal blue 008



Forca da scuderia in plastica ABS antiurto. Misura Unica.

High-quality ABS plastic fork. One size.

Colori/Colors

- black 001
- red 003
- royal blue 008
- burgundy 006



■ L ■ Made in Italy



Umbria
equitazione srl
Official

www.umbriaequitazione.com

315

Forca da scuderia in plastica ABS antiurto special fork, alta flessibilità sia ad alte che a basse temperature. Misura Unica. Colori come da catalogo.

High-quality ABS plastic fork. High flexibility at high or low temperatures.

One size. Colors as catalogue.

■ L ■ Made in Italy

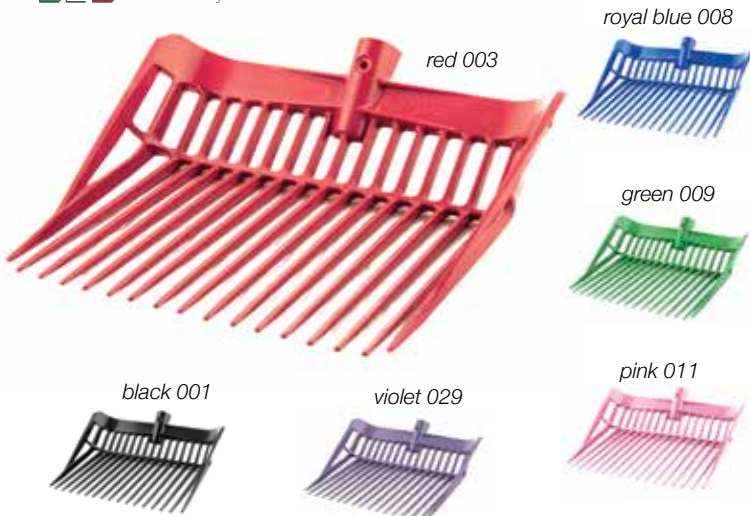

Forca arrotondata semicurva in plastica resistente con denti flessibili. Misura Unica.

High-quality plastic rounded fork with high flexibility tines. One size.

Colori/Colors

- black 001
- red 003
- grey 020



Forca in plastica ABS antiurto "Pegasus" con cestello. Misura Unica. Colore: nero.

High-quality ABS plastic fork type "Pegasus". One size. Color: black.



Forca da scuderia in plastica ABS antiurto, alta flessibilità sia ad alte che a basse temperature. Misura Unica. Colore: nero.

High-quality ABS plastic fork. High flexibility at high or low temperatures.

One size. Color: black.



art. VA00398A

Forca da scuderia in plastica resistente con cestello. Colori: Rosso, Nero
Plastic stall fork. One size. Colors: red, black, royal blue.

Colori/Colors

- black 001
- red 003



art. VA00393

Forca da scuderia in plastica ABS antiurto con cestello. Colore Nero.
High-quality ABS plastic stall fork. Black Color.

■ L ■ Made in Italy



art. VA00401



Forca da scuderia DuraFork in plastica ABS antiurto con cestello, alta flessibilità, qualità TOP. Misura Unica. Colore Rosso

DuraFork ABS plastic stall fork made in USA. High flexibility, TOP quality. One size. Red Color.



art. VA00389



Forca da scuderia DuraFork in plastica ABS antiurto, alta flessibilità, qualità TOP con manico in alluminio ergonomico. Colore Rosso.

Durafork ABS plastic fork with aluminium ergonomic handle. Red Color.



art. VA00397



Forca da scuderia DuraFork in plastica ABS antiurto, alta flessibilità, qualità TOP. Misura Unica. Colori: Rosso, Nero, Verde, Royal Blue.

DuraFork ABS plastic fork made in USA. High flexibility, TOP quality. One size. Colors: Red, Black, Green, Royal Blue.



Progettate per un uso duraturo, extra-forte 100% in policarbonato, forniscono super forza e flessibilità.

Denti appositamente angolati sono progettati unicamente per fornire una facile presa sul letame con meno perdite.

Designed for long-lasting use from extra-strong 100 percent polycarbonate to provide super strength and flexibility. Specially designed tines are uniquely angled to provide easy manure pickup with less spilling.

Umbria
EQUITAZIONE

Forca in plastica ABS antiurto "Pegasus" con cestello e manico in alluminio. Misura Unica. Colore Nero. High-quality ABS plastic fork type "Pegasus" with aluminium handle. Black color. art. VA00404



Umbria
EQUITAZIONE

Forca in plastica ultra resistente con manico ergonomico per un lavoro in posizione verticale e con minore fatica. Colore Nero. High-resistance plastic fork with ergonomic handle. The curved handle means that you always stand upright and don't have to bend your back. Black color. art. VA00407



Umbria
EQUITAZIONE

Forca arrotondata semicurva in plastica resistente con denti flessibili con manico alluminio. Misura Unica. Colori Vari. High-quality plastic rounded fork with high flexibility tines complete with aluminium handle. One size. Various colors. art. VA00406



Umbria
EQUITAZIONE

Forca da scuderia in plastica resistente con cestello e manico in alluminio. Misura Unica. Colori: Rosso, Nero. Plastic stall fork with aluminium handle. One size. Colors: red, black, royal blue. art. VA00398



Umbria
equitazione srl
Official

www.umbriaequitazione.com

317

Box & Grooming

Umbria
EQUITAZIONE

Forca da scuderia in plastica resistente con manico in ferro. Misura Unica. Colori: Rosso, Nero, Azzurro. Plastic fork with handle. One size. Colors: red, black, royal blue. art. VA00395



Umbria
EQUITAZIONE

Forca da scuderia in ferro con manico in ferro. Misura Unica. Colore Unico. Iron fork with handle. One size. Unique color. art. VA00391



Umbria
EQUITAZIONE

Palo in alluminio per forca. Misura unica. Aluminium fork handle. One size. art. VA00398B



Umbria
EQUITAZIONE

Palo in ferro per forca. Misura unica. Iron fork handle. One size. art. VA00413



Umbria
EQUITAZIONE

Palo in legno per forca. Misura unica. Wooden fork handle. One size. art. VA00392



Umbria
EQUITAZIONE

Palo ergonomico in legno per forca VA00396. Ergonomic wooden handle for fork VA00396. art. VA00399A



Umbria
EQUITAZIONE

Palo in legno per pala in plastica. Misura unica.
Wooden shovel handle. One size.
art. VA00412



Umbria
EQUITAZIONE

Pala in metallo con manico in legno. Misura Unica. Colore Unico.
Metallic shovel with wooden handle. Unique color.
art. VA00409



Umbria
EQUITAZIONE

Manico in legno per scopa. Misura Unica.
Wooden broom handle. One size.
art. VA00415



Umbria
EQUITAZIONE

Pala in plastica con bordo in ferro. Misura Unica. Colore Unico.
Plastic shovel with iron edge. Unique color.
art. VA00411



Umbria
EQUITAZIONE

Scopa in plastica. Misura Unica. Colore Unico.
Plastic broom. One size. Unique color.
art. VA00414



Umbria
EQUITAZIONE

Pattumiera in plastica da scuderia con rastrello. Misura Unica. Colori: Nero, Rosso.
Stable mate. One size. Colors: black, red.
art. VA00920



Umbria
EQUITAZIONE

Stuoino in gomma. Misura Unica. Colori Vari
Rubber sole clean carpet. One size. Various colors.
art. VA00980

Umbria
EQUITAZIONE

Scopa da box con manico in alluminio. Misura Unica. Colore Unico.
Stable broom with aluminum handle. One size. Unique color.
art. VA00410



Umbria
EQUITAZIONE

Pulisci stivali da pavimento. Misura Unica.
Wooden boots cleaner. One size.
art. VA01150





Umbria
equitazione srl
Official



Umbria
EQUITAZIONE

art. VA00008
art. VA00009

Carrello con ruote sterzanti, ripiano in plastica antiurto e maniglione ripiegabile. Misure come da catalogo. Colore Unico.
Foldable stable cart with high-resistance plastic shelf and steering wheels. Measures such as catalog tab. Unique color.

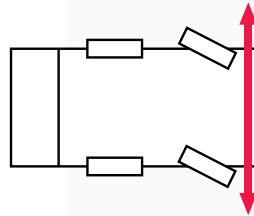

Ruote Sterzanti
Steering Wheels



www.umbriaequitazione.com

319

Box & Grooming

MAX
150Kg

MAX
300Kg

art. VA00008

art. VA00009

dimensione | dimensions 86H x 46W x 71L (cm)

dimensione | dimensions 86H x 60W x 115L (cm)

peso | weight 9 Kg

peso | weight 16 Kg

capacità di carico | load capacity 150 Kg

capacità di carico | load capacity 300 Kg

Umbria
EQUITAZIONE

art. VA00910

Carriola in ferro zincato con rinforzo antiusura e vasca in plastica ABS antiurto da 160 litri. Misura Unica. Colore Unico.

High-resistance ABS plastic barrow with galvanized body with wheels.
Capacity: 160 litres. One size. Unique color.

Umbria
EQUITAZIONE

art. VA00911

Carriola ripieghevole in alluminio e nylon rinforzato. Misura Unica. Colore Unico.

Foldable reinforced nylon barrow with aluminium body. One size. Unique color.

160
Lt.



Specifiche Prodotto



Struttura: Compensato fenolico da mm. 9

Misure baule: cm. 60x65x124

Profili e accessori: Bordature in alluminio; Chiusura ermetica in alluminio; Rinforzi angolari a 4 punti di fissaggio; Cantionali con palla antiurto; N°2 Griglie di aereazione; N°2 Clipper porta-lucchetti; N°3 Cerniere ad apertura di 180°; N°2 Maniglie con molla di ritorno; N°1 Portaindirizzo; N°1 Maniglione di movimentazione sul dietro; N°2 Ruote ad incasso cerchio zincato dim.260 N°2 Ruote dim.80 girevoli blu con freno; N°1 Ruota dim.80 girevole montata al coperchio; Tutti gli accessori hanno finitura zincata bianca.

Caratteristiche interne: Fodera TNT nero; Porta cassetto con porta briglie con asta telescopica per asciugatura sella; N°1 Portasella doppio; N°1 Attacco stampella + stampella autobloccante; N°2 supporti di tenuta inferiore in lamiera zincata 10/10; N°1 cassetto ad estrazione totale; N°2 Tubi porta-frustino.

Colori | Colours

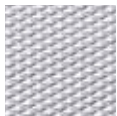

alluminio | aluminum

Product Specification

Structure:

Phenolic polywood mm. 9

Trunk measures:

cm. 60x65x124

Profiles and accessories:

Edgings aluminum; Airtight aluminum; Corner reinforcements to 4 fixing points; Cantonal ball impact absorber; N 2 ventilation grilles; N 2 Clipper door-locks; N 3 hinges opening of 180°; N 2 Handles with return spring; N 1 address tag; N 1 Long handle handling on behind; N 2 Wheels recessed circle galvanized dim.260; N 2 dim.80 swivel wheels with brake blue; N 1 Wheel dim.80 swivel mounted to the cover; All accessories have a galvanized finish white

Interior Features:

TNT black lining; Door drawer door bridle with telescopic boom drying saddle; N 1 double saddle carriers; N 1 Attack + crutch crutch locking N 2 supports lower sealing galvanized 10/10; N 1 drawer full extension; N 2 Tubes door-whip.



art. VA00952



Umbria
equitazione srl
Official

MADE IN
ITALY

Box & Grooming

320

www.umbriaequitazione.com

Specifiche Prodotto

Struttura: Compensato fenolico da mm. 9

Misure baule: cm. 60x65x124

Profili e accessori: Bordature in alluminio; Chiusura ermetica in alluminio; Rinforzi angolari a 4 punti di fissaggio; Cantionali con palla antiurto; N°2 Griglie di aereazione; N°2 Clipper porta-lucchetti; N°3 Cerniere ad apertura di 180°; N°2 Maniglie con molla di ritorno; N°1 Portaindirizzo; N°1 Maniglione di movimentazione sul dietro; N°2 Ruote ad incasso cerchio zincato dim.260 N°2 Ruote dim.80 girevoli blu con freno; N°1 Ruota dim.80 girevole montata al coperchio; Tutti gli accessori hanno finitura zincata bianca.

Caratteristiche interne: Fodera TNT nero; Porta cassetto con porta briglie con asta telescopica per asciugatura sella; N°1 Portasella doppio; N°1 Attacco stampella + stampella autobloccante; N°2 supporti di tenuta inferiore in lamiera zincata 10/10; N°1 cassetto ad estrazione totale; N°2 Tubi porta-frustino.



Colori | Colours

burgundy 006

navy blu 004

hunter green 005

black 001

Product Features

Structure:

Phenolic plywood mm. 9

Trunk measures:

cm. 60x65x124

Profiles and accessories:

Edgings aluminum; Airtight aluminum; Corner reinforcements to 4 fixing points; Cantonal ball impact absorber; N 2 ventilation grilles; N 2 Clipper door-locks; N 3 hinges opening of 180°; N 2 Handles with return spring; N 1 address tag; N 1 Long handle handling on behind; N 2 Wheels recessed circle galvanized dim.260; N 2 dim.80 swivel wheels with brake blue; N 1 Wheel dim.80 swivel mounted to the cover; All accessories have a galvanized finish white

Interior Features:

TNT black lining; Door drawer door bridle with telescopic boom drying saddle; N 1 double saddle carriers; N 1 Attack + crutch crutch locking N 2 supports lower sealing galvanized 10/10; N 1 drawer full extension; N 2 Tubes door-whip.



art. VA00954

MADE IN
ITALY

Specifiche Prodotto

Struttura: Compensato fenolico da mm. 9

Misure baule: cm. 60x65x124

Profili e accessori: Bordature in alluminio; Chiusura ermetica in alluminio; Rinforzi angolari a 4 punti di fissaggio; Cantonal con palla antiurto; N°2 Griglie di aereazione; N°2 Clipper porta-lucchetti; N°3 Cerniere ad apertura di 180°; N°2 Maniglie con molla di ritorno; N°1 Portaindirizzo; N°1 Maniglione di movimentazione sul dietro; N°2 Ruote ad incasso cerchio zincato dim.260 N°2 Ruote dim.80 girevoli blu con freno; N°1 Ruota dim.80 girevole montata al coperchio; Tutti gli accessori hanno finitura zincata bianca.

Caratteristiche interne: Fodera TNT nero; Asta telescopica per asciugatura sella; N°1 Portasella doppio; N°1 Attacco stampella + stampella autobloccante; N°2 supporti di tenuta inferiore in lamiera zincata 10/10; N°2 Tubi porta-frustino.

Colori | Colours

aluminum 019

black 001

Product Features

Structure:

Phenolic plywood mm. 9

Trunk measures:

cm. 60x65x124

Profiles and accessories:

Edgings aluminum; Airtight aluminum; Corner reinforcements to 4 fixing points; Cantonal ball impact absorber; N 2 ventilation grilles; N 2 Clipper door-locks; N 3 hinges opening of 180°; N 2 Handles with return spring; N 1 address tag; N 1 Long handle handling on behind; N 2 Wheels recessed circle galvanized dim.260; N 2 dim.80 swivel wheels with brake blue; N 1 Wheel dim.80 swivel mounted to the cover; All accessories have a galvanized finish white

Interior Features:

TNT black lining; Telescopic boom drying saddle; N 1 double saddle carriers; N 1 Attack + crutch crutch locking N 2 supports lower sealing galvanized 10/10; N 2 Tubes door-whip.

art. VA00950



www.umbriaequitazione.com

321

Box & Grooming

Specifiche Prodotto

Armadio portasella in plastica; leggero, robusto, e disponibile in 2 fantastici colori (verde scuro, nero). All'interno sono presenti due portasella, 2 appendibriglia e un ampio spazio libero. Dotato di 2 chiusure anteriori, 2 ruote e un pratico maniglione per un trasporto facile e leggero. Dimensions approx. 113 cm H x 62 cm W x 70 cm D

Product Features

Saddle cabinet of plastic; light, robust, and available in 2 fantastic colours (dark green, black). The cabinet is delivered with 2 saddle holders and 2 bridle holders, 1 storage compartment in the door and two front closures. Dimensions approx. 113 cm H x 62 cm W x 70 cm D

Colori | Colours

Verde Scuro | Dark Green

Nero | Black



art. VA00955



art. VA00956

Specifiche Prodotto

Armadio zincato completamente smontabile. Comprende: 2 portasella, 2 appendi briglia, 1 scaffale. Dimensioni: 106 cm H x 60 cm W x 60 cm D

Product Features

Galvanized Kit saddle cabinet. Includes: 2 saddle rack, 2 bridle holder, 1 shelves. Dimensions: 106 cm H x 60 cm W x 60 cm D



Umbria
equitazione srl
Official

MADE IN
ITALY



Umbria
EQUITAZIONE

Poggiasella multiplo in ferro zincato smontabile a 5 posti. Misura Unica. Colore Unico. Detachable galvanized multi-saddle rack. One size. Unique color. art. VA00820

Umbria
EQUITAZIONE

Portasella multiplo in metallo con ruote. Misura Unica. Colore Unico. Multi-pole saddle rack with heavy wheels. One size. Unique color. art. VA00901



Umbria
EQUITAZIONE

Poggiasella in ferro da stazionata a due posti. Misura Unica. Colore Unico. Portable saddle rack with two hooks. One size. Unique color. art. VA00295



Umbria
EQUITAZIONE

Carrello portasella e bauletto in metallo con ruote ed impugnatura. Misura Unica. Colore Unico. **N.B. bauletto non incluso.** Saddle rack with two wheels and handle. One size. One color. Grooming box is not included. art. VA00900



Umbria
EQUITAZIONE

Poggiasella a 3 gambe smontabile. Misura Unica. Colori: Rosso, Nero. Collapsible saddle stand. One size. Color: red, black. art. VA00300



Umbria
EQUITAZIONE

Portasella multiplo in ferro con braccia orientabili. Misura Unica. Colore Unico. Detachable multi-saddle rack with swivel arms. One size. Unique color. art. VA00822

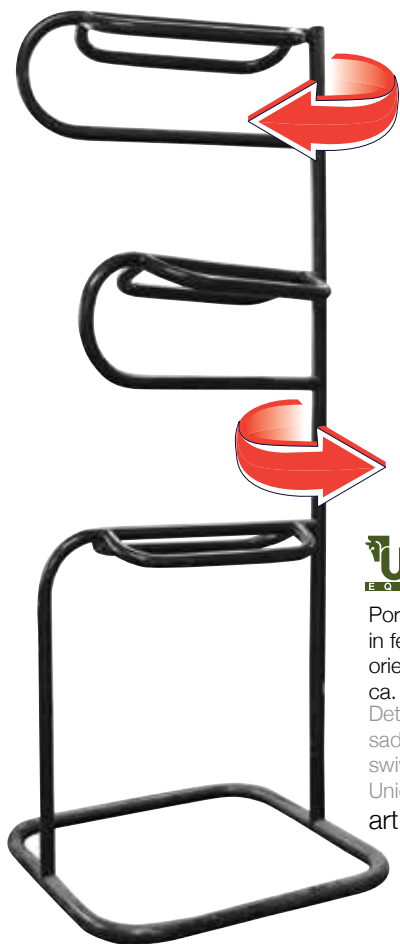



Umbria
EQUITAZIONE

Poggiasella pieghevole in alluminio con ruote e sacca in nylon. Misura Unica. Colore Unico.
Aluminium foldable saddle rack on wheels with nylon bag. One size. Unique color.
art. VA00803B



Umbria
EQUITAZIONE

Poggiasella pieghevole in metallo con porta bauletto. Misura Unica. Colore Unico.
Folding floor saddle rack. One size. Unique color.
art. VA00800



Umbria
equitazione srl
Official

www.umbriaequitazione.com

323

Box & Grooming

Umbria
EQUITAZIONE

Poggiasella fisso da muro per sella inglese. Misura Unica. Colori: Rosso, Nero.
Wall saddle rack for english saddle. One size. Colors: red, black.
art. VA00290



Umbria
EQUITAZIONE

Poggiasella ripieghevole da muro per sella inglese. Misura Unica. Colori: Rosso, Nero.
Folding saddle rack for english saddle. One size. Colors: red, black.
art. VA00291



Umbria
EQUITAZIONE

Poggiasella fisso da muro per sella americana. Misura Unica. Colori: Rosso, Nero.
Wall saddle rack for western saddle. One size. Colors: red, black.
art. VA00294



Umbria
EQUITAZIONE

Poggiasella ripieghevole da muro per sella americana. Misura Unica. Colori: Rosso, Nero.
Folding saddle rack for western saddle. One size. Colors: red, black.
art. VA00293

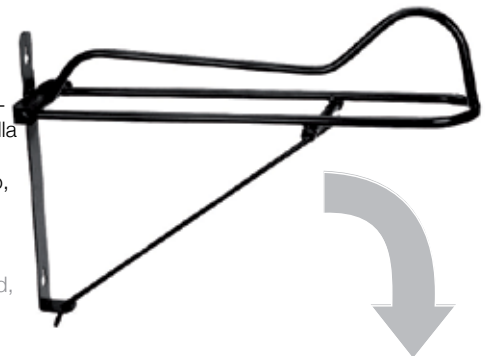

Umbria
EQUITAZIONE

Portasella da viaggio ripiegabile. Misura Unica. Colore: nero.
Collapsible saddle stand. One size.
art. VA00297



Umbria
EQUITAZIONE

Poggiasella da van pieghevole. Misura Unica. Colori: Rosso, Nero.
Easy fold saddle bracket. One size. Colors: red, black.
art. VA00292



art. VA00798

Provasella in legno robusto modello "Ranger". Misura Unica. Colore Unico.
Wooden saddle stand type "Ranger". One size. Unique color.



art. VA00800A

Poggiasella smontabile in alluminio robusto. Misura Unica. Colore Unico.
Aluminum detachable saddle stand with strong body. One size. Unique color.



324

www.umbriaequitazione.com

Box & Grooming



Umbria
equitazione srl
Official

art. VA00829

Provasella da terra in vetroresina sagomato rivestito in tessuto scamosciato.
Modello "Passionate Experts". Misura Unica. Colore Unico.
Fiberglass shaped saddle stand suede covered. Type "Passionate Experts".
One size. Unique color.



art. VA00829W

Provasella da terra in vetroresina sagomato rivestito in tessuto scamosciato.
Modello "Pool's". Misura Unica. Colore Unico.
Fiberglass shaped saddle stand suede covered. Type "Pool's". One size.
Unique color.



www.umbriaequitazione.com

www.umbriaequitazione.com

Umbria

Barra appendicoperte in metallo. Misura Unica. Colore Unico.
Metallic cooler/blanket rack.
One size. Unique color.
art. VA00801

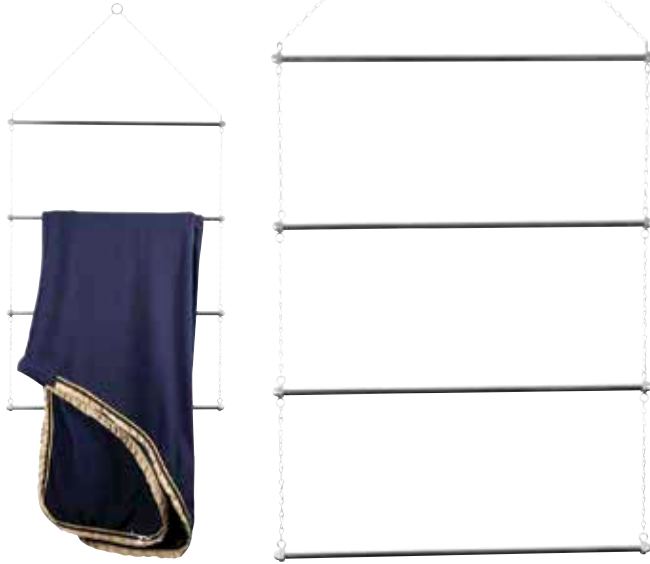

Umbria

Barra appendicoperte in legno. Misura Unica. Colore Unico.
Metallic cooler/blanket rack with wooden bars.
One size. Unique color.
art. VA00805



Umbria
equitazione srl
Official

www.umbriaequitazione.com

325

Box & Grooming

Umbria

Barra appendicoperte in alluminio ripiegabile a muro. Misura Unica. Colore Unico.
Collapsible horse clothing bar. One size. Unique color.
art. VA00828

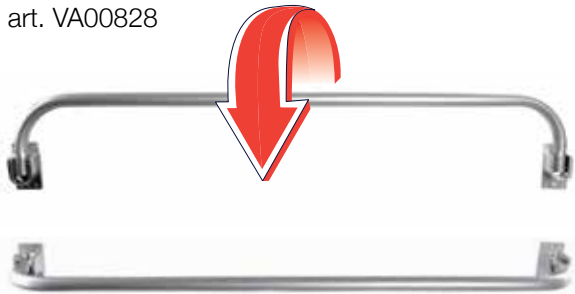

Umbria

Barra appendicoperte larga in ferro ripiegabile a muro. Misura Unica. Colore Unico.
Collapsible horse clothing bar. One size. Unique color.
art. VA00828A

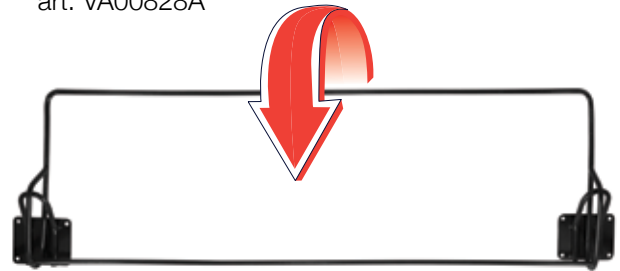

Umbria

Porta asciugamani in ottone. Misura Unica. Colore Unico
Brass towel bar. One size. Unique color.
art. GA00510



Umbria

Porta asciugamani tondo in ottone. Misura Unica. Colore Unico
Brass towel rack. One size. Unique color.
art. GA00500



Umbria

Barra appendicoperte regolabile in metallo. Misura Unica. Colore Unico.
Adjustable horse clothing bar. One size. Unique color.
art. VA00819

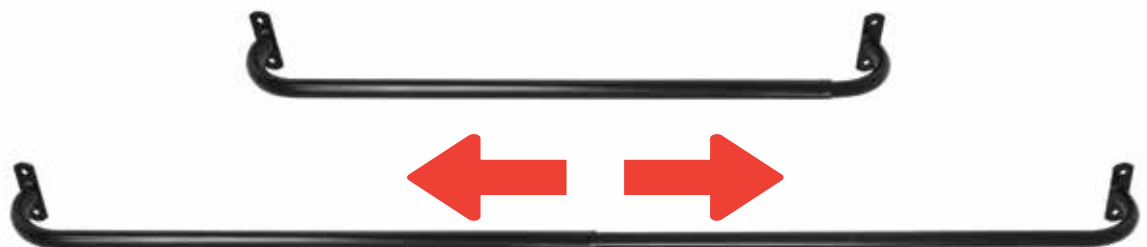

Umbria
EQUITAZIONE

art. VA00355

Gancio da scuderia a forma di ferro di cavallo. Misura Unica. Colore: nero.
Horseshoe bridle bracket. One size. Color: black.



Umbria
EQUITAZIONE

art. VA00310

Appendibriglie in ferro plastificato. Misura Unica. Colore Rosso, Nero.
Metal with vinyl coated bridle bracket. One size. Colors: red, black.



Umbria
EQUITAZIONE

art. VA00312

Appendibriglie a forma di testa di cavallo. Misura Unica. Colore Unico.
Horse head bridle bracket. One size. Unique color.



Umbria
EQUITAZIONE

art. VA00177

Appendibriglie ad anello con gancio. Misura Unica. Colore Unico.
Display ring. One size. Unique color.



Umbria
EQUITAZIONE

art. VA00313A

Appendibriglie a forma di ferro e testa di cavallo. Misura Unica. Colore Unico.
Horse head and horseshoe bridle bracket. One size. Unique color.



Umbria
EQUITAZIONE

art. VA00313

Appendibriglie in ghisa a forma di ferro e testa di cavallo. Misura Unica. Colore: nero.
Horse head and horseshoe bridle bracket. One size. Color: nero.



Umbria
EQUITAZIONE

art. VA00530

Anello zincato con piastra per box. Misura Unica. Colore Unico.
Stamped steel plate cross tie ring. One size. Unique color.



Umbria
EQUITAZIONE

art. VA00531

Anello da box a vite. Misura Unica. Colore Unico.
Stamped steel plate screw eye ring. One size. Unique color.



326
www.umbriaequitazione.com

Box & Grooming



Umbria
EQUITAZIONE

art. VA00311A

Appendibriglie multiplo snodato. Misura Unica. Colore: nero.
Halter tack rack with hooks that rotate. One size. Color: black.



Umbria
EQUITAZIONE

art. VA00311

Appendibriglie multiplo fisso. Misura Unica. Colore: nero.
Halter tack rack with four hooks. One size. Color: black.

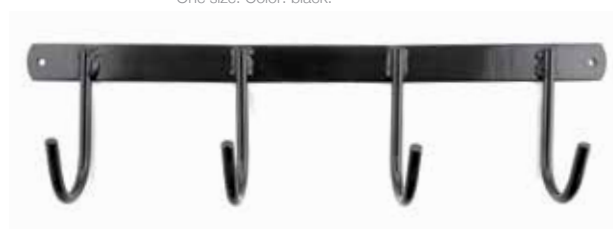

Umbria
EQUITAZIONE

art. VA00309A

Gancio da staccinata per appendibriglie ad ancora. Misura Unica. Colore Unico.
Foldable harness hanger. One size. Unique color.



Umbria
EQUITAZIONE

art. VA00309

Appendibriglie multiplo ad ancora. Misura Unica. Colori: nero, rosso, argento.
Harness hook made of strong steel. One size. Various black, red, silver.

Umbria
EQUITAZIONE

art. VA00301

Appendibriglie multiplo da box con ganci. Misura Unica. Colore: nero.
Portable halter tack rack with four hooks. One size. Color: black.



art. VA00513

Tendalino chiudi box in cordura con bordo e passamaneria. Parte centrale removibile. Colore Unico. Misure: l 93 cm x h 53 cm.

Lami-Cell stable curtain with cord and detachable straps. Unique color. Dimensions: h 53 x l 93 cm.



art. VA00375

Chiudi box in nylon regolabile con moschettoni. Dimensioni in cm: circa 82 x 38.

Nylon adjustable stall guard with six attachment snap hooks. Dimensions: h 38 x l 82 cm. Colors: black, red, royal blue, green.

Colori/Colors

- green 009
- red 003
- navy blu 004
- royal blue 008



Umbria
equitazione srl
Official

www.umbriaequitazione.com

327

Box & Grooming



art. VA00514

Tenda da box Lami-Cell con riquadro removibile e ricamabile. Dimensioni in cm: circa 220 x 167. Misura Unica. Colore: navy blu.

Lami-Cell stable curtain with cord and detachable straps. Dimensions: h 220 x l 167 cm. Color: navy blue.



Rete
Net



art. VA00510

Tenda da box corta in cordura con bordo e passamaneria. Dimensioni: circa h 120 x l 125. Misura Unica. Colori: Blu, Verde, Bordeaux.

Lami-Cell stable curtain with cord. Dimensions: approx h 120 x l 120 cm. Colors: navy, green, burgundy.



art. VA00511

Tenda da box lunga in cordura con bordo e passamaneria. Dimensioni: circa h 200 x l 120.

Lami-Cell stable curtain with cord. Dimensions: approx h 200 x l 116 cm.

Colori/Colors

- navy blu 004
- hunter green 005
- burgundy 006



Umbria
EQUITAZIONE

art. VA00500

Coppia di tendistivali in alluminio.
Misura Unica. Colore Unico.
Aluminum boot shaper. One size.
Unique color. Sold in pairs.



Umbria
EQUITAZIONE

art. VA00158

Cavastivali in legno. Misura Unica.
Colore Unico.
Wooden boot jack. One size.
Unique color.



Umbria
EQUITAZIONE

art. VA00130A

Cavastivali in plastica e rivestimento in
gomma. Misura Unica. Colore Unico.
Plastic boot jack. One size. Unique
color.



328

www.umbriaequitazione.com



Umbria
equitazione srl
Official

Accessori Vari - Various Accessories



Umbria
EQUITAZIONE

art. VA00814

Garresometro in alluminio ripiega-
bile. Misura Unica. Colore Unico.
Aluminum horse measure standard
deluxe. One size. Unique color.



Umbria
EQUITAZIONE

art. VA00811

Garresometro a bastone in legno.
Misura Unica. Colore Unico.
Wooden horse measure. One size.
Unique color.



Umbria
EQUITAZIONE

art. VA00812

Seggiolino portatile ripieghevole.
Misura Unica. Colore Unico.
Portable folding seat. One size.
Unique color.

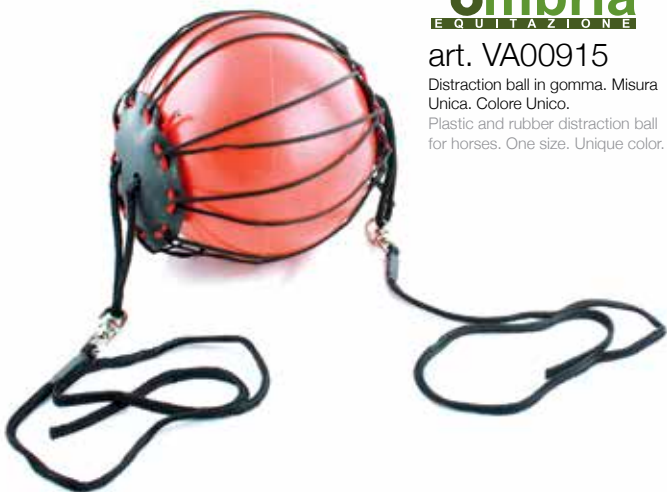

Umbria
EQUITAZIONE

art. VA00915

Distraction ball in gomma. Misura
Unica. Colore Unico.
Plastic and rubber distraction ball
for horses. One size. Unique color.

Umbria
EQUITAZIONE

art. VA00908

Distraction ball in gomma piena.
Misura Unica. Colori Vari.
Rubber distraction ball for horses.
One size. Various colors.



Umbria
EQUITAZIONE

art. LC972

Distraction ball gonfiabile. Misura
Unica. Colori: Rosso, Royal
Rubber distraction ball for horses. One
size. Colors: red, royal blue.



LAKOTA SADDLERY CO. ZA

art. LK8011

Collare anti-tic in cuoio e metallo.
Misura Unica. Colore Unico.
Aluminium hinge cribbing with leather strap. One size. Unique color.



Umbria EQUITAZIONE

art. VA00170B

Collare anti-tic in nylon e metallo.
Misura Unica.
Aluminium hinge cribbing with nylon strap. One size.

Colori/Colors

- brown 010
- black 001
- red 003
- royal blue 008

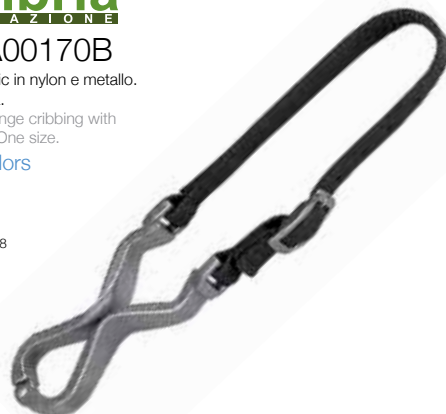

LAKOTA SADDLERY CO. ZA

art. LK8010

Collare anti-tic in cuoio modello americano. Misura Unica. Colori: naturale, testa di moro.

Leather anti-cribbing leather type american. One size. Colors: natural, brown.



Umbria EQUITAZIONE

art. VA00686

Collare a stecche per medicazioni.
Misura Unica. Colore Unico.
Wooden neck cradle. One size. Unique color.



Umbria EQUITAZIONE

art. VA00683

Guaina per la sudorazione del collo del cavallo. Misura Grande.
Neoprene full neck sweat. Big size.

Colori/Colors

- black 001
- red 003
- royal blue 008



Umbria EQUITAZIONE

art. VA00682

Guaina per la sudorazione del collo del cavallo. Misura Piccola.
Neoprene half neck sweat. Small size.

Colori/Colors

- black 001
- red 003
- royal blue 008

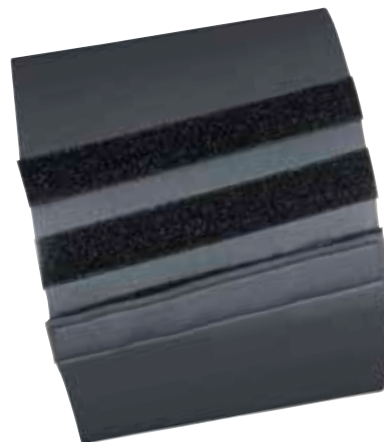

Umbria
equitazione srl
Official



art. VA6009

Cartello "Trasporto animali vivi" triangolare in plastica per van. Misura Unica. Colore Unico. Plastic triangle signboard. One size. Unique color.



art. VA00700

Targa da segnalazione per box in plastica. Misura Unica. Colore Unico. Plastic stall plaque. One size. Unique color.

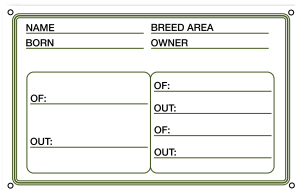

art. VA00699

Targa da segnalazione per box in alluminio. Misura Unica. Colore Unico. Aluminum stall plaque. One size. Unique color.



art. VA00930

Lettere da dressage, set 4 pezzi. Misura Unica. Colore Unico. Show dressage markers. Set of 4 pieces. One size. Unique color.

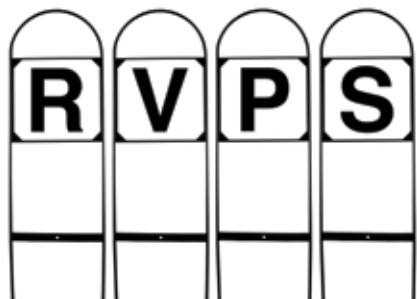

art. VA00940

Lettere da dressage, set 8 pezzi. Misura Unica. Colore Unico. Show dressage markers. Set of 8 pieces. One size. Unique color.

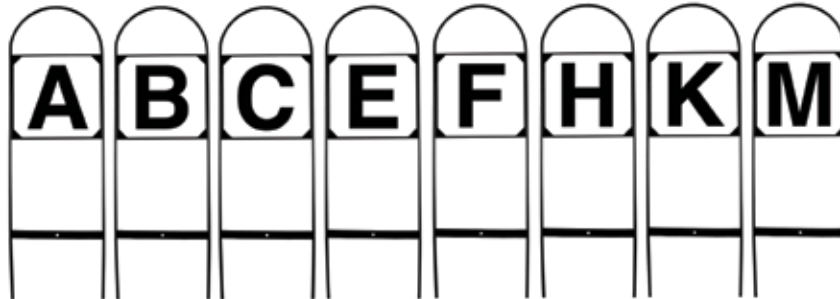

art. VA00940A

Lettere da dressage, set 12 pezzi. Misura Unica. Colore Unico. Show dressage markers. Set of 12 pieces. One size. Unique color.

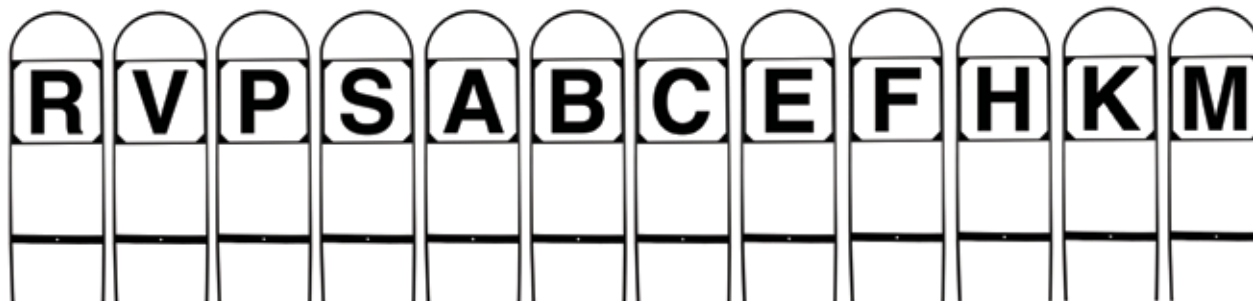

art. VA00942

Coni da dressage, set 4 pezzi RSVP. Misura Unica. Colore Unico. Show dressage cones. Set of 4 pieces. One size. Unique color.

art. VA00941

Coni da dressage, set 8 pezzi AFBMCHEK. Misura Unica. Colore Unico. Show dressage cones. Set of 8 pieces. One size. Unique color.



art. VA000931

Numeri da salto ostacoli, set 12 pezzi. Misura Unica. Colore Unico. Show jumping markers. Set of 12 pieces. One size. Unique color.

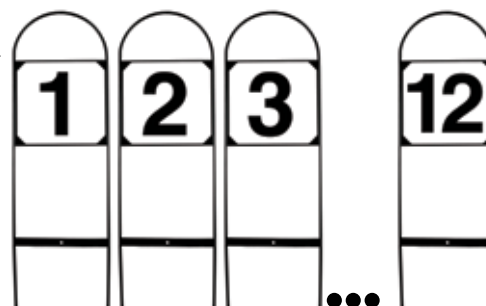

Umbria
EQUITAZIONE

art. VA00180

Pinza fustellatrice per la lavorazione del cuoio e della pelle con 6 punzoni intercambiabili.
Leather punch with 6 interchangeables tubes.



Umbria
EQUITAZIONE

art. VA00182

Pinza fustellatrice professionale a leva, per la lavorazione del cuoio e della pelle.
Professional leather punch with 6 interchangeables tubes.



Umbria
EQUITAZIONE

art. VA00186

Foratrice professionale per cuoio e pelle in acciaio con 8 punzoni intercambiabili.
Single tube leather punch with 8 interchangeables tubes.



Umbria
EQUITAZIONE

art. VA00684

Borraccia foderata con bordo in alluminio.
Misura Unica. Colore Unico.
Blanket cover canteen. One size.
Unique color.



Umbria
EQUITAZIONE

art. VA00181

Pinza fustellatrice professionale in acciaio per la lavorazione del cuoio e della pelle.
Professional stainless steel leather punch with 6 interchangeables tubes.



Umbria
EQUITAZIONE

art. VA00183

Pinza fustellatrice per la lavorazione del cuoio e della pelle.
Leather punch with 6 interchangeables tubes.



Umbria
EQUITAZIONE

art. VA01111

Bussola per trekking a cavallo in metallo.
Trekking compass.



Umbria
EQUITAZIONE

art. VA00818

Borraccia tascabile in acciaio. Misura Unica.
Colore Unico.
Stainless steel quart pot. One size.
Unique color.



Umbria
equitazione srl
Official

art.CK00045

Briglia da Horse Ball in cuoio completa di redini in gomma. Misure: Pony, Cob, Full. Colore: Nero.

Leather Horse Ball bridle with rubber covered reins. Sizes: Pony, Cob, Full. Colors: Black.



art. HB00020

Briglia da Horse Ball in Biothane completa di redini in gomma. Misure: Pony, Cob, Full. Colore: Nero, Marrone.

Biothane Horse Ball bridle with rubber covered reins. Sizes: Pony, Cob, Full. Colors: Black.



332

www.umbriaequitazione.com

Horse Ball



Palla da Horse Ball con maniglie in cuoio.

Misure: 3, 4, 5. Colore Unico.

Horse Ball balloon with leather handles.

Sizes: 3, 4, 4. Unique color.

art. HB00011 taglia | size 5

art. HB00010 taglia | size 4

art. HB00009 taglia | size 3



art. HB00040

Laccio per staffe da Horse Ball in biothane.

Misura Unica. Colori: Marrone, Nero.

Horse Ball stirrup strap in biothane. One size.

Colors: Brown, Black.



art. HB00030

Martingala inglese a collier per Horse Ball in cuoio.

Misure: Pony, Cob, Full. Colore: Nero, Testa Di Moro.

Leather Horse Ball martingale. Sizes: Pony, Cob, Full.

Colors: Brown, Black



Horse Ball

1:1 QUARTER HORSE



art. VA00909

Umbria
EQUITAZIONE

Cavallo smontabile in plastica Quarter. Misura Unica. Colori: Nero, Marrone.

Display horse-disassemble type Quarter. One size. Colors: Black, Brown.



Umbria
equitazione srl
Official

www.umbriaequitazione.com

333

art. VA00907

Umbria
EQUITAZIONE

Testa di cavallo in vetroresina verniciato a mano con supporto in legno. Misura Unica. Colori Vari.
Hand painted fiberglass horse head with wooden support. One size. Various colors.



art. VA00906

Umbria
EQUITAZIONE

Arto anteriore in plastica. Misura Unica. Colore Unico.
Plastic fore leg. One size. Unique color.

art. VA00906P

Arto posteriore in plastica. Misura Unica. Colore Unico.
Plastic hind leg. One size. Unique color.



Accessori e Giochi - Accessories and Toys



art. GA00070

Umbria
EQUITAZIONE

Pony in peluche sonoro con due motivi, capacità di carico fino a 100 Kg.
Dimensioni: lunghezza 80 cm, altezza sella 55 cm, altezza testa 68 cm.
Colore Unico.

Pony peluche with two sounds. Carrying capacity up to 100 Kg. Dimensions: length 80 cm, seat height 55 cm, head height 68 cm. Unique color.



Breyer

art. BY1409

Set con bambola e cavallo collezione "Let's go riding-English".
Horse and doll set "Let's go riding-English" collection.



Breyer

art. BY61053

Set completo con bambola e cavallo "Kaitlyn Cowgirl".
Horse and doll set "Kaitlyn Cowgirl" collection.



Breyer

art. BY8256

Totilas. Collezione "Reigning World Dressage Champion".
Totilas. "Reigning World Dressage Champion" collection.



Breyer

art. BY934

Cavallo "Silver Bay Mustang" in scala 1:12 dipinto a mano.
"Silver Bay Mustang" horse. Scale 1:12, hand painted.



Breyer

art. BY931

Cavallo "Quarter Horse" in scala 1:12 dipinto a mano.
"Quarter Horse" horse. Scale 1:12, hand painted.



Breyer

art. BY62032

Set fattrice e puledro "Appaloosa" in scala 1:12 dipinto a mano.
"Appaloosa" mare and foal set. Scale 1:12, hand painted.



Breyer

art. BY62031

Set fattrice e puledro "Thoroughbred" in scala 1:12 dipinto a mano.
"Thoroughbred" mare and foal set. Scale 1:12, hand painted.

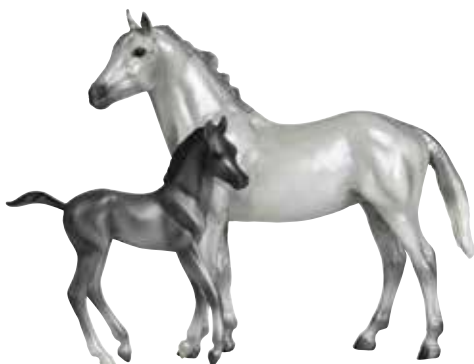

Breyer

art. BY62033

Set fattrice e puledro "Warmblood" in scala 1:12 dipinto a mano.
"Warmblood" mare and foal set. Scale 1:12, hand painted.



Breyer

art. BY1439

Cavallo "Hickstead" con coperta in scala 1:9 dipinto a mano.
"Hickstead" horse with rug. Scale 1:9, hand painted.





art. BY5908

Cavallo in scala 1:32 a scelta. Venduto singolarmente.
Horse in scale 1:32. Sold individually.



Knabstrupper



Cob



Mustang



Frosted Purple



Purple



American Spotted Draft Horse



Hanoverian



American Quarter Horse



Frosted Blue



Frosted Pink



Arabian



Sport Horse



Frosted Green



Pink



Umbria
equitazione srl
Official

www.umbriaequitazione.com

335

Giocattoli - Toys



art. BY5414

Set completo "New Arrival" in
scala 1:32. Come da foto.
"New Arrival" complete set in scale
1:32. As in the picture.



art. BY61058

Set completo "Show Jumping" in
scala 1:12. Come da foto.
"Show Jumping" complete set in
scale 1:32. As in the picture.



art. BY1601

Portagioie con carillon musicale.
Misure in cm: 15 x 10 x 15.
Jewelry box with music box.
Measures in cm: 15 x 10 x 15.



art. BY61072

Set completo "English Jumping" in
scala 1:12. Come da foto.
"English Jumping" complete set in
scale 1:12. As in the picture.



art. BY61074

Set completo "Stable Cleaning" in
scala 1:12. Come da foto.
"Stable Cleaning" complete set in
scale 1:12. As in the picture.



art. BY2477

Set completo "Stable Cleaning" in
scala 1:9. Come da foto.
"Stable Cleaning" complete set in
scale 1:9. As in the picture.





art. BY61060

Furgoncino pronto soccorso con luci "Classic Mobile Vet Clinic" in scala 1:12
Classic mobile vet clinic in scale 1:12.



art. BY5356

Set composto da jeep e trailer in scala 1:32. *Personaggi e Cavalli non inclusi
Truck & gooseneck trailer in scale 1:32. *Characters and horses are not included



art. BY5352

Set composto da jeep e trailer in scala 1:32. * Personaggi e Cavalli non inclusi
Animal rescue set in scale 1:32. *Characters and horses are not included



art. BY61075

Set di accessori per alimentazione "Stable Feeding" in scala 1:12.
"Stable Feeding" complete set in scale 1:12.



art. BY59197

Stalla completa di due cavalli "Red Stable With Two Horses" in scala 1:32.
Red stable with two horses in scale 1:32.



art. BY5370

Set completo "Crazy Pocket Barn" con fienile, cavallo e ragazza in scala 1:32.
Crazy pocket barn in scale 1:32.



art. BY699

Stalla con angolo per il lavaggio "Classics Country Stable" in scala 1:12.
Classic country stable in scale 1:12.



Cavalli e Accessori non inclusi all'interno della confezione
Horse and Accessories are not included in the package



art. BY302

Fienile in legno "Deluxe Wood Barn with Cupola" in scala 1:9.
Deluxe wood barn with cupola in scale 1:9.



Cavalli e Accessori non inclusi all'interno della confezione
Horse and Accessories are not included in the package



Umbria
EQUITAZIONE

art. GA00970

Trofeo cavallino rampante con base in ottone. Misure: cm 18x12x16.
Brass standing horse trophy. Size: cm 18x12x16.



Umbria
EQUITAZIONE

art. GA00980

Trofeo cavallo con base in ottone. Misure: cm 23x26x19.
Brass horse trophy. Size: 23x26x19.



Umbria
EQUITAZIONE

art. GA00950

Trofeo cavallo con base in legno. Misure: cm 23x24x16.
Brass horse trophy with wooden pedestal. Size: 23x24x16.



Umbria
EQUITAZIONE

art. GA00997

Appendibriglia a testa di cavallo da scuderia in ottone. Misure: cm 14.
Brass horse head bridle bracket. Size: cm 14.



Umbria
equitazione srl
Official

www.umbriaequitazione.com

337

Umbria
EQUITAZIONE

art. GA00991

Portachiavi da muro soggetto "Cavallo al trotto". Misure: cm 20x11.
Brass "Trot horse" keychain holder. Size: cm 20x11.



Umbria
EQUITAZIONE

art. GA00990

Portachiavi da muro soggetto "Carrozza". Misure: cm 20x11.
Brass "Carriage" keychain holder. Size: cm 20x11.



Umbria
EQUITAZIONE

art. GA00920

Appendi abiti in ottone a 3 ganci. Misure: cm 36x10.
Brass clothes hanger. Size: 36x10.



Umbria
EQUITAZIONE

art. GA00930

Posacenere in ottone a ferro di cavallo. Misure: cm 14x12.
Brass horseshoe ashtray. Size: cm 14x12.



Umbria
EQUITAZIONE

art. GA00994

Set completo per caminetto in ottone. Misura Unica.
Brass fireplace kit. One size.



Umbria
EQUITAZIONE

art. GA00996

Tagliacarte in ottone con testa di cavallo. Misure: cm 16.
Brass paper knife with horse head. Size: cm 16.



Umbria
EQUITAZIONE

art. GA00995

Calzascarpe in ottone. Misure: cm 22.
Brass shoehorn. Size: 22 cm.



Umbria
EQUITAZIONE

art. GA00960

Cavastivali e calzascarpe in ottone con testa di cavallo. Misure: cm 69.
Brass shoehorn and boot jack with horse head. Size: cm 69.



Umbria
EQUITAZIONE

art. GA00940

Calzascarpe in ottone con testa di cavallo. Misure: cm 42.
Brass shoehorn with horse head handle. Size: cm 42.



art. GA00993

Coppia di alari per caminetto in ottone. Misure: cm 32x38.
Brass andirons for fireplace. Measures: cm 32x38.



Umbria
EQUITAZIONE

Umbria
EQUITAZIONE

art. GA00992

Apri bottiglie in ottone con testa di cavallo. Misure: cm 10.
Brass corkscrew with horse head. Measures: cm 10.



art. GA00052

Braccialeto in metallo decorazione 6 teste. Misura Unica.

Metal bracelet with 6 horse head decoration. One size.

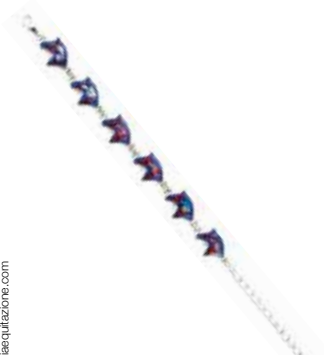

art. GA00051

Ciondolo per portachiavi in colore blu o rosa. Misura Unica.

Keychain pendant in pink or blue color. One size.



art. GA00053

Collana in metallo con ciondolo fantasia. Misura Unica.

Necklace with fantasy horse head pendant. One size.



art. GA00054

Orecchini in metallo a testa di cavallo colorata. Misura Unica.

Fantasy horse head earrings. One size.



art. GA00055

Orecchini lunghi con testa di cavallo e diamante. Misura Unica.

Earrings with horse head pendant. One size.



art. GA00108

Portachiavi in metallo con testa di cavallo colorata. Misura Unica.

Metal keychain with horse head. Colors as catalogue. One size.



art. GA00100B

Portachiavi in argento con testa di cavallo. Misura Unica.

Silver plated keychain with horse head. One size.



art. GA00100D

Portachiavi in argento con ferro di cavallo. Misura Unica.

Silver plated keychain with horseshoe. One size.



art. GA00100

Portachiavi in argento con riporto royal e testa di cavallo. Misura Unica.

Silver plated keychain with horse head. One size.



art. GA00105

Portachiavi in alluminio colorato tipo moschettone. Misura Unica.

Aluminum horse head keychain. One size. Various colors.



art. GA00102B

Portachiavi a ferro di cavallo in acciaio. Misura Unica.

Nickel plated horseshoe keychain. One size.



art. GA00102

Portachiavi a ferro di cavallo in ottone. Misura Unica.

Golden brass plated horseshoe keychain. One size.



art. GA00101

Portachiavi a filetto in ottone. Misura Unica.

Golden brass plated ring snaffle bit keychain. One size.



art. GA00101B

Portachiavi a filetto in acciaio. Misura Unica.

Nickel plated ring snaffle bit keychain. One size.



art. GA00101A

Portachiavi a filetto a D in acciaio. Misura Unica.

Nickel plated dee snaffle bit keychain. One size.



art. GA00104

Portachiavi a staffa in acciaio. Disponibile anche in ottone.

Nickel plated stirrup keychain. One size.



art. GA00103-103A

Portachiavi a sperone western. Misura Unica. Nickel plated western spur keychain. One size.



art. GA00103B

Portachiavi a morso western in acciaio. Misura Unica. Nickel plated western bit keychain. One size.



art. GA00060

Portachiavi a pistola con fondina in cuoio. Misura Unica. Metal gun with leather holster keychain. One size.



art. GA00050

Portachiavi a sella western cuoio. Misura Unica. Leather western saddle keychain. One size.



Umbria
equitazione srl
Official

art. VA00817

Portachiavi in gomma Lilliput a striglia. Misura Unica. Colori Vari. Rubber curry comb keychain. One size. Various colors.



art. VA00817A

Portachiavi in gomma Lilliput a paraglo. Misura Unica. Colori Vari. Rubber bell boot keychain. One size. Various colors.



art. VA01001

Lucchetto a forma di testa di cavallo in gomma. Misura Unica. Rubber horse head with padlock. One size.



art. GA00061

Cavatappi in acciaio a forma di stivale. Misura Unica. Stainless steel riding boot bottle opener. One size.



art. GA00162

Trofeo cavallino rampante con base in legno. Misura piccola. Standing horse trophy with wooden pedestal. Small size.



art. GA00161

Trofeo cavallino rampante con base in legno. Misura Media. Standing horse trophy with wooden pedestal. Large size.



art. GA00160

Trofeo testa di cavallo con base in legno. Misura Unica. Horse head trophy with wooden pedestal. One size.



art. GA00170

Trofeo salto a ostacoli con base in legno. Misura Unica. Show jumping horse trophy with wooden pedestal. One size.



art. GA00201

Coccarda bicolore con soggetto testa di cavallo. Misura Unica. Colori come da catalogo. Two-tone horse medallion with horse head. One size. Colors as catalog



art. GA00200

Coccarda tricolore Italia con soggetto testa di cavallo. Misura Unica. Italian colors horse medallion with horse head. One size.



art. GA00202

Coccarda tricolore Italia con soggetto personalizzabile. Misura Unica. Customizable horse medallion. One size.



*ordine minimo
100 pezzi.
*minimum quantity
100 pcs.

art. GA00825 n°1 working cow ll



art. GA00825 n°2 arabian mare and foal



art. GA00825 n°3 show jumping

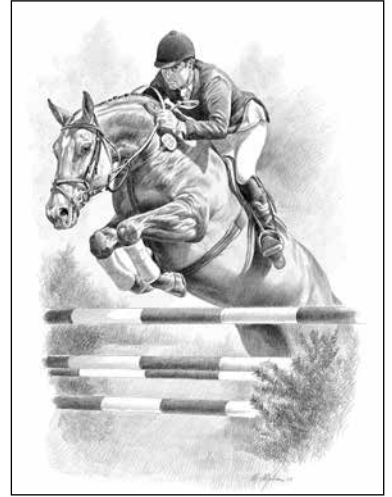

art. GA00825 n°6 reinerstop



art. GA00825 n°4 quarter mare and foal



art. GA00825 n°5 face to face



art. GA00825 n°7 friesian stallion



art. GA00825 n°8 arabians stallions



art. GA00825 n°9 cool waters

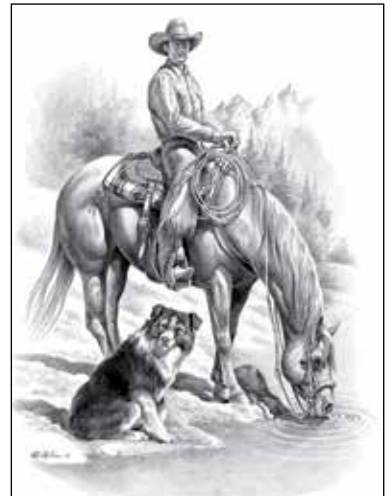

art. GA00825 n°10 spanish head



art. GA00825 n°11 first run



art. GA00825 n°12 the last cut



art. GA00825 n°13 levada



art. GA00825 n°14 working cow



art. GA00825 n°15 corbeta



art. GA00825 n°16 barrel racing



art. GA00825 n°17 cowboy horse & foal



art. GA00825 n°18 cowboy & calf



art. GA00825 n°23 team penning

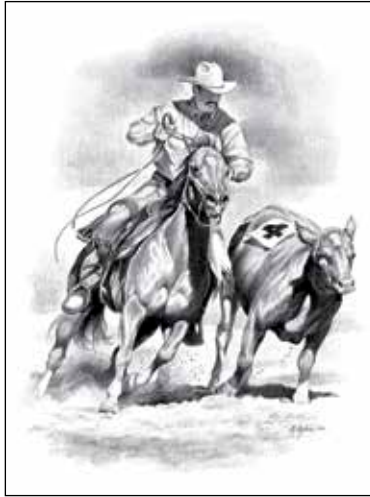

art. GA00825 n°24 nearing pass

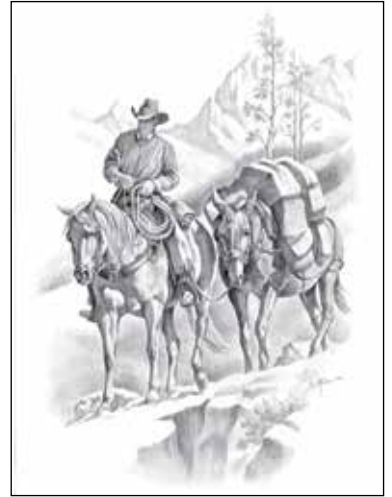

art. GA00825 n°19 running with the mare



art. GA00825 n°20 mother and son



art. GA00825 n°22 last born

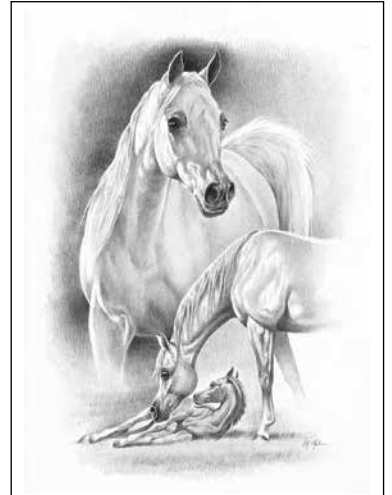

art. GA00825 n°21 arabian family



Umbria
EQUITAZIONE

art. GA00825

Stampa a carboncino con soggetti equestri. Misura Unica.

Print with equestrian subjects. One size.

misura I size 35x50 cm

art. VA00320

Moschettone per redini con cameretta tonda. Misura Unica. Colori: Silver, Gold.

Scissor snap with round swivel eye. One size. Colors: chrome plated, golden brass plated.



art. VA00320A

Moschettone per redini con cameretta quadrata. Misura Unica. Colori: Silver, Gold.

Scissor snap with square swivel eye. One size. Colors: chrome plated, golden brass plated.



art. VA00326

Moschettone per testiera con cameretta quadra. Misura Unica. Colori: Silver, Gold.

Spring snap with square fixed eye. One size. Colors: chrome plated, golden brass plated.



art. VA00326A

Moschettone in ottone per testiera con cameretta tonda. Misura Unica. Colori: Gold.

Spring snap with round fixed eye. One size. Colors: solid brass.



art. VA00317A

Moschettone universale con cameretta quadra. Misura Unica. Colori: Silver.

Square eye swivel bolt snap. One size. Color: chrome plated.



art. VA00317

Moschettone universale con cameretta tonda. Misura Unica. Colori: Silver, Gold.

Round eye swivel bolt snap. One size. Colors: chrome plated, solid brass.



art. VA00321

Moschettone per lunghina in ottone con cameretta tonda. Misura Unica. Colori: Gold.

Bolt brass snap with round swivel eye. Medium size. Color: solid brass.



art. VA00322

Moschettone per lunghina in ottone con cameretta tonda. Misura Unica. Colori: Gold.

Bolt brass snap with round swivel eye. Large size. Color: solid brass.



art. VA00322B

Moschettone per lunghina con cameretta tonda. Misura Unica. Colori: Silver.

Bolt snap with round swivel eye. Large size. Color: chrome plated.



art. VA00367

Moschettone per lunghina con cameretta tonda. Misura Unica. Colori: Silver.

Bolt snap with round swivel eye. Large size. Color: chrome plated.



art. VA00823

Moschettone universale. Misura unica. Colori: Silver.

Spring snap. One size. Color: chrome plated.



art. VA00319

Moschettone doppio. Misura Unica. Colori: Silver.

Double end snap. One size. Color: chrome plated.



art. VA00319A

Moschettone doppio. Misura Unica. Colori: Gold.

Double end snap. One size. Color: golden brass plated.



art. VA00323

Moschettone antipanico con cameretta fissa. Misura Unica. Colori: Silver, Gold.

Panic snap with fixed round eye. One size. Colors: chrome plated, golden brass plated.



art. VA00323A

Moschettone antipanico con cameretta girevole. Misura Unica. Colori: Silver, Gold.

Panic snap with swivel round eye. One size. Colors: chrome plated, golden brass plated.



art. VA00324

Moschettone antipanico con ghiera girevole in ottone. Misura Unica. Colori: Gold.

Security snap with round swivel eye. One size. Color: solid brass.



art. VA00689A

Moschettone per lunghina. Misura Unica. Colori: Silver, Gold.

Rope clam. One size. Colors: chrome plated, golden brass plated.



art. VA00689B

Moschettone per lunghina. Misura Grande. Colori: Gold.

Rope clam. Large size. Color: golden brass plated.



art. VA00689

Moschettone per lunghina pesante in ottone. Misura Unica. Colori: Silver, Gold.

Heavy duty rope clam. One size. Colors: chrome plated, solid brass.



art. VA00364

Anello per cavezza. Misura Piccolo, Medio, Grande. Colori: Silver, Gold.

Halter ring. Sizes: Small, Medium, Large. Colors: chrome plated, golden brass plated.



art. VA00362

Anello per cavezza con triangolo. Colori: Gold.
Halter ring with triangle. One size. Color: golden brass plated.



art. VA00308

Fibbia a farfalla in ottone per cavezza. Misura: Piccola. Colori: Gold.
Brass halter square 3-way. Small size. Color: solid brass plated.



art. VA00308A

Fibbia a farfalla per cavezza. Misura: Media, Grande. Colori: Gold.
Halter square 3-way. Large size. Color: golden brass plated.



art. VA00694A

Catena per lunghina. Misura Unica. Colori: Gold.
Lead chain with swivel. One size. Color: golden brass plated.



art. VA00694

Catena per lunghina. Misura Unica. Colori: Silver.
Lead chain with swivel. One size. Color: chrome plated.



Umbria equitazione srl Official

art. VA00365

Anello con gancio fisso per tie-down. Misura Unica. Colori: Gold.
Loop and ring. One size. Color: golden brass plated.



art. VA00314

Fibbia per cavezza. Misure: 16 mm, 19 mm, 25 mm. Colori: Silver, Gold.
Swedge buckle with center bar. Sizes: 16 mm, 19 mm, 25 mm. Colors: chrome plated, golden brass plated.



art. VA00361

Fibbia per barbozzale. Misure: 16 mm, 19 mm, 25 mm. Colori: Silver, Gold.
Center bar buckle. Sizes: 16 mm, 19 mm, 25 mm. Colors: chrome plated, golden brass plated.



art. VA00318

Fibbia con doppio aggancio. Misure: 16 mm, 19 mm. Colori: Silver, Gold.
Double bar buckle. Sizes: 16 mm, 19 mm, 25 mm. Colors: chrome plated, golden brass plated.



art. VA00696

Fibbia per staffili in acciaio. Misure: 19 mm, 25 mm. Colori: Silver.
SS english stirrup buckle. Sizes: 19 mm, 25 mm. Color: stainless steel.



art. VA00318C

Fibbia per sottogola western. Misure: 16 mm. Colori: Silver.
Heel buckle. Sizes: 16 mm. Color: chrome plated.



art. VA00318B

Fibbia per sottogola inglese. Misure: 16 mm. Colori: Gold.
Buckle with loose roller. Sizes: 16 mm. Color: golden brass plated.



art. VA00318A

Fibbia per sottogola inglese. Misure: 19 mm. Colori: Silver.
Roller buckle. Sizes: 19 mm. Color: chrome plated.



art. VA00316A

Fibbia per lacci per speroni inglesi. Misure: 13 mm. Colori: Silver.
Buckle with center bar. Sizes: 13 mm. Color: chrome plated.



art. VA00314A

Fibbia per testiera western. Misure: 16 mm, 19 mm. Colori: Silver.
Heel buckle. Sizes: 16 mm, 19 mm. Color: chrome plated.



art. VA00325A

Fibbia con perno. Misure: 13 mm, 16 mm, 19 mm, 25 mm. Colori: Gold.
Conway buckle. Sizes: 13 mm, 16 mm, 19 mm, 25 mm. Colors: golden brass plated.



art. VA00325

Fibbia con perno. Misure: 13 mm, 16 mm, 19 mm, 25 mm. Colori: Silver.
Conway buckle. Sizes: 13 mm, 16 mm, 19 mm, 25 mm. Colors: silver plated.



art. VA00687

Fibbia per sella western. Misure: Piccola, Media. Colori: Silver.
Clip and dees. Sizes: Small, Medium. Color: stainless steel.



art. VA00687A

Fibbia per sella western. Misure: Grande. Colori: Silver.
Clip and dees. Sizes: Large. Color: stainless steel.



art. VA00315A

Fibbia per sottopancia inglese. Misura Unica. Colori: Silver.
English girth buckle with roller. One size. Color: stainless steel.



art. VA00368

Fibbia per sottopancia inglese con molla in acciaio. Misura Unica. Colori: Silver.
SS english girth buckle with roller and spring. Color: stainless steel.



art. VA00815

Set da 3 pezzi di fibbie per coperta. Misura Unica. Colori: Silver.
Surcingle set. One size. Color: chrome plated.



art. VA00315

Fibbia per sottopancia western. Misura Unica. Colori: Silver.
Western girth buckle. One size. Color: chrome plated.



art. LK8030

Laccioli in cuoio al cromo. Misura circa 140 cm. Colori: Marrone, Naturale.
Square leather fastening laces. Length: 140 cm. Colors: Brown, Natural.



art. LK8031

Laccioli in cuoio lattigo da 1 cm. Misura circa 150 cm. Colore Unico.
Latigo leather laces. Length: 150 cm. One color.



art. VA00693

Borchia per sottopancia posteriore con viti. Misure: circa 8,8 x 4,4 cm. Colori: Silver. Venduta singolarmente
Billet slot with screws. Measures: approx 8,8 x 4,4 cm. Color: silver plated.
Sold individually.



art. VA00692

Decorazione per sella western con viti. Misure: circa 16 x 3,6 cm. Colori: Silver.
Cantle trim with screws. Measures: approx 16 x 3,6 cm. Color: silver plated.



art. VA00693C

Borchia angolare per sella western con viti. Misure: circa 9,5 x 4 cm. Colori: Silver. Venduta in coppia.
Saddle corner trim with screws. Measures: approx 9,5 x 4 cm. Color: silver plated. Sold in pairs



art. VA00693B

Borchia angolare per sella western con viti. Misure: circa 8,8 x 8,8 cm. Colori: Silver. Venduta in coppia.
Saddle corner trim with screws. Measures: approx 8,8 x 8,8 cm. Color: silver plated. Sold in pairs.



art. VA00693A

Borchia angolare per sella western con viti. Misure: circa 14 x 12,5 cm. Colori: Silver. Venduta in coppia.
Saddle corner trim with screws. Measures: approx 14 x 12,5 cm. Color: silver plated. Sold in pairs.



art. VA00695

Borchia per sella western a vite. Misure: Piccola, Media, Grande. Colori: Silver.
Concho with screw. Size: Small, Medium, Large. Color: silver plate.



art. VA00695A

Borchia per sella western a vite. Misure: Media, Grande. Colori: Silver.
Concho with screw. Size: Medium, Large. Color: silver plate.



art. VA00695D

Borchia per sella western a vite. Misura: Unica. Colori: Silver.
Concho with screw. One size. Color: silver plate.



art. VA00702

Borchia per sella western a vite decorazione "Chain". Misura: Piccola, Media. Colori: Brunito
Concho with screw "Chain" design. Size: Small, Medium. Color: Antique Brown



art. VA00702B

Borchia per sella western a vite decorazione "Star". Misura: Piccola, Media. Colori: Brunito
Concho with screw "Star" design. Size: Small, Medium. Color: Antique Brown



art. VA00702E

Borchia per testiera western con vite decorazione "Cow Horse". Misura: Unica. Colori: Brunito
Concho with screw "Cow Horse" design. One size. Antique Brown



art. VA00695B

Borchia per testiera western con vite decorazione "Star". Misura: Unica. Colori: Brunito
Concho with screw "Star" design. One size. Antique Brown



art. VA00702D

Borchia per testiera western con vite decorazione "Chain". Misura: Unica. Colori: Brunito
Concho with screw "Chain" design. One size. Antique Brown



art. VA00681

Set di 10 viti miste per testiera "Chicago Screws". Misura Unica. Colore come catalogo.
Set of 10 mixed "Chicago Screws". One size. Color as catalogue.



art. VA00327

Conchos in metallo per sella western. Misure: Ø 3,4 - 2,6 cm. Colori: Silver
Concho. Size: Ø 3,4 - 2,6 cm. Color: silver plate.



art. VA00703

Conchos in metallo per sella western. Misure: Ø 3,9 cm. Colori: Brunito
Concho. Size: Ø 3,9 cm. Color: silver plate.



art. VA00704

Fibbia per testiera western modello "Silver Star". Misura: 1,6 cm. Colori: Silver
Buckle with "Silver Star" design. Size: 1,6 cm. Color: silver plated.



art. VA00701D

Passante per testiera western modello "Silver Star". Misure: 1,6 cm. Colori: Silver
Loop with "Silver Star" design. Size: 1,6 cm. Color: silver plated.



art. VA00701C

Puntale per testiera western modello "Silver Star". Misura: 1,6 cm. Colori: Silver
Tips with "Silver Star" design. Size: 1,6 cm. Color: silver plated.



art. VA00704A

Fibbia per testiera western modello "Stars". Misura: 1,6 cm. Colori: Brunito
Buckle with "Stars" design. Size: 1,6 cm. Color: Antique Brown.



art. VA00701

Passante per testiera western modello "Star". Misure: 1,6 cm. Colori: Brunito
Loop with "Stars" design. Size: 1,6 cm. Color: Antique Brown.



art. VA00701A

Puntale per testiera western modello "Star". Misure: 1,6 cm. Colori: Brunito
Tip with "Stars" design. Size: 1,6 cm. Color: Antique Brown.



art. VA00704B

Fibbia per testiera western modello "Chain". Misure: 1,6 cm. Colori: Brunito
Buckle with "Chain" design. Size: 1,6 cm. Color: Antique Brown.



art. VA00701E

Passante per testiera western modello "Chain". Misure: 1,6 cm. Colori: Brunito
Loop with "Chain" design. Size: 1,6 cm. Color: Antique Brown.



art. VA00701B

Puntale per testiera western modello "Chain". Misure: 1,6 cm. Colori: Brunito
Tip with "Chain" design. Size: 1,6 cm. Color: Antique Brown.



Art. n°	Colore Colour	Lunghezza Length	Larghezza Width
DG84992	marrone brown	100 cm	70 cm
DG84993	marrone brown	120 cm	85 cm



Pet Cushion Oxford



- destinato ad un impiego per interno ed esterno
- rivestimento solido, impermeabilizzato, resistente allo sporco, lavabile a 30°
- con cerniera, tela Oxford, 100% polyester
- for indoor and outdoor use
- robust, water and dirt repellent cover, washable up to 30 °C
- zipped, oxford fabric, 100 % polyester

Transport Bag Journey



- nylon resistente e lavabile con rete resistente per la circolazione dell'aria
- 2 aperture sul lato anteriore e posteriore, con scomparto per piccoli oggetti
- con tappetino integrato in pellicetta lavabile a 30° e tracolla regolabile removibile. Modello ripiegabile salvaspazio inclusa borsa di nylon
- durable, washable nylon material, strong mesh netting for air circulation
- 2 openings on the front and back, including small parts compartment
- with integrated mat in lambs fleece look (washable at 30 °C) and detachable, adjustable shoulder strap. Space-saving, fold-down design

Art. n°	Altezza Height	Lunghezza Length	Larghezza Width
DG81355	22,5 cm	40 cm	20 cm
DG81356	28 cm	48 cm	27 cm



Transport Box Journey



- materiale in nylon resistente e lavabile, con 3 modalità di apertura
- utilizzabile all'interno ed all'esterno, modello stabile grazie al telaio metallico
- rete resistente per la circolazione dell'aria
- con stuoia integrata in pellicetta (lavabile a 30°), tasche laterali, portabottiglie, picchetti e maniglia
- piedini in gomma per una migliore aderenza al suolo
- durable, washable nylon material with 3 opening options
- can be used indoors and outdoors, stable design thanks to metal frame
- strong mesh netting for air circulation
- with integrated mat in lambs fleece effect (washable at 30 °C), side pockets, bottle holder, pegs and holding handle
- rubber feet for better base grip



Art. n°	Altezza Height	Lunghezza Length	Larghezza Width
DG81350	43 cm	61 cm	45,5 cm
DG81351	48 cm	76 cm	50,5 cm
DG81352	58 cm	91 cm	61 cm
DG81353	68,5 cm	106 cm	71 cm



Chain Collar

Strangolatore a catena con anelli lunghi. Massima resistenza, anelli saldati.
Chain Collar with Long Links. Extremely robust, ARGON-welded rings

Art. n°	Materiale Material	Lunghezza Length	Spessore Thickness
DG83373	cromato chrome plated	46 cm	3,0 mm
DG83374	cromato chrome plated	50 cm	3,0 mm
DG83375	cromato chrome plated	55 cm	3,0 mm
DG83376	cromato chrome plated	59 cm	4,0 mm
DG83377	cromato chrome plated	63 cm	4,0 mm
DG83378	cromato chrome plated	72 cm	4,0 mm



Umbria
equitazione srl
Official



Classic Basic

Guinzaglio Flexi classico Basic. Guida retrattile da 5 m (XS: guida da 3 m).
Leash Classic Basic with retractable cord leash up to 5 m.
(size XS: up to 3 m).

Art. n°	Colore Colour	Misura Size	Peso Cane Dog Weight
DG82196	rosso red	XS	max. 8 Kg
DG82199	nero black	XS	max. 8 Kg
DG83297	rosso red	S	max. 12 Kg
DG83298	nero black	S	max. 12 Kg
DG83300	rosso red	M	max. 20 Kg
DG83301	nero black	M	max. 20 Kg



Classic Long

Guinzaglio Flexi classico Lungo con guida retrattile da 7 m.
Leash Classic Long with extra long retractable cord leash up to 7 m.

Art. n°	Colore Colour	Misura Size	Peso Cane Dog Weight
DG82201	rosso red	S	max. 12 Kg
DG82203	nero black	S	max. 12 Kg
DG83306	rosso red	M	max. 20 Kg
DG83307	nero black	M	max. 20 Kg
DG83309	rosso red	L	max. 50 Kg
DG83310	nero black	L	max. 50 Kg



Classic Compact

Guinzaglio Flexi classico Compatto con cinghia avvolgibile da 5 m.
Leash Classic Compact with retractable tape leash up to 5 m.

Art. n°	Colore Colour	Misura Size	Peso Cane Dog Weight
DG84322	rosso red	M	max. 25 Kg
DG84323	nero black	M	max. 25 Kg

Miami Training

Guinzaglio Miami da addestramento.
Training Leash Miami.

Art. n°	Colore Colour	Lunghezza Length	Larghezza Width
DG83692	nero black	200 cm	15 mm
DG83693	blu royal	200 cm	15 mm
DG83694	rosso red	200 cm	15 mm
DG82154	viola violet	200 cm	15 mm
DG83696	nero black	200 cm	20 mm
DG83697	blu royal	200 cm	20 mm
DG83698	rosso red	200 cm	20 mm
DG82155	viola violet	200 cm	20 mm
DG83712	nero black	200 cm	25 mm
DG83713	blu royal	200 cm	25 mm
DG83714	rosso red	200 cm	25 mm
DG82156	viola violet	200 cm	25 mm





Miami Soft

Guinzaglio Miami con presa morbida.
Leash Miami with Softgrip.

Art. n°	Colore Colour	Lunghezza Length	Larghezza Width
DG83671	rosso red	100 cm	20 mm
DG83670	blu royal	100 cm	20 mm
DG83669	nero black	100 cm	20 mm
DG82153	viola violet	100 cm	20 mm

Miami Collar

Collare Miami regolabile.
Adjustable Miami collar.

Art. n°	Colore Colour	Circ. Collo Neck Circ.	Larghezza Width
DG83716	nero black	20 - 35 cm	10 mm
DG83717	blu royal	20 - 35 cm	10 mm
DG83718	rosso red	20 - 35 cm	10 mm
DG83700	nero black	30 - 45 cm	15 mm
DG83701	blu royal	30 - 45 cm	15 mm
DG83702	rosso red	30 - 45 cm	15 mm
DG83704	nero black	40 - 55 cm	20 mm
DG83705	blu royal	40 - 55 cm	20 mm
DG83706	rosso red	40 - 55 cm	20 mm
DG83708	nero black	45 - 65 cm	25 mm
DG83709	blu royal	45 - 65 cm	25 mm
DG83710	rosso red	45 - 65 cm	25 mm



Harness Miami

Bardatura Miami con 5 tipi di regolazione.
Harness Miami, 5 times adjustable.

Art. n°	Colore Colour	Circ. Petto Chest Circ.	Larghezza Width
DG84350	nero black	30 - 40 cm	15 mm
DG84351	blu royal	30 - 40 cm	15 mm
DG84352	rosso red	30 - 40 cm	15 mm
DG82157	viola violet	30 - 40 cm	15 mm
DG84354	nero black	40 - 57 cm	15 mm
DG84355	blu royal	40 - 57 cm	15 mm
DG84356	rosso red	40 - 57 cm	15 mm
DG82158	viola violet	40 - 57 cm	15 mm
DG84358	nero black	55 - 76 cm	20 mm
DG84359	blu royal	55 - 76 cm	20 mm
DG84360	rosso red	55 - 76 cm	20 mm
DG82159	viola violet	55 - 76 cm	20 mm
DG84362	nero black	75 - 100 cm	25 mm
DG84363	blu royal	75 - 100 cm	25 mm
DG84364	rosso red	75 - 100 cm	25 mm
DG82160	viola violet	75 - 100 cm	25 mm



Miami Plus

Bardatura Miami Plus con imbottitura morbida e design extra solido.
Harness Miami Plus with soft padding, extra robust.

Art. n°	Colore Colour	Circ. Petto Chest Circ.	Peso Weight
DG83940	nero black	65 - 75 cm	200 gr
DG83941	nero black	65 - 85 cm	222 gr
DG83942	nero black	70 - 90 cm	240 gr
DG83943	nero black	80 - 100 cm	281 gr



Reflective!



Harness Maestro

- distribuzione ottimale della pressione grazie all'imbottitura
- maniglia integrata, regolazione a variazione continua, rivestimenti cromati
- cinghia anteriore e cuciture riflettenti, interno in morbido polyester
- optimised pressure distribution thanks to pressure-relieving padding
- integrated holding handle, smoothly adjustable, chrome-plated fittings
- reflective chest strap and seams, interior made from softly polyester

Art. n°	Colore Colour	Circ. Petto Chest Circ.	Larghezza Width
DG82182	nero-rosso black-red	44 - 55 cm	25 mm
DG82183	nero-rosso black-red	55 - 70 cm	38 mm
DG82184	nero-rosso black-red	65 - 85 cm	38 mm
DG82185	nero-rosso black-red	70 - 87 cm	50 mm
DG82186	nero-rosso black-red	80 - 109 cm	50 mm



KERBL

Training Dummy

Gioco da addestramento, resistente al morso e galleggiante.
Training Dummy, firm to the bite due to internal rubber coating, floatable.

Art. n°	Colore Colour	Lunghezza Length	
DG82300	unico one color	31 cm	



Umbria
equitazione srl
Official

KERBL

Training Dummy

- con zip e chiusura aggiuntiva in velcro
- promuove attenzione, obbedienza e recupero attraverso il gioco
- in materiale robusto ed idrorepellente, 100% polyester
- with zip and additional Velcro fastener
- promotes attentiveness and obedience through play
- robust, water and dirt-repellent material, 100 % polyester

Art. n°	Colore Colour	Lunghezza Length	Larghezza Width
DG82264	nero black	23 cm	7 cm



349

Articoli per Cani - Pet Articles



KERBL

Bag for Doodoo Pouch

Borsa per sacchetti igienici in nylon. Contiene 2 confezioni da 20 sacchetti.
Bag for Doodoo Pouch made in nylon. Include 2 rolls of 20 bags

Art. n°	Colore Colour	Lunghezza Length	Larghezza Width
DG83453	nero black	8 cm	5,5 cm

KERBL

Replacement Doodoo Pouch

Sacchetti igienici di ricambio in plastica. 4 rotoli da 20 sacchetti a confezione.
Replacement Doodoo Pouch. Made in plastic, 4 rolls of 20 bags each.

Art. n°	Colore Colour	Lunghezza Length	Larghezza Width
DG83459	nero black	8 cm	5,5 cm
DG82267	colorato colorful	8 cm	5,5 cm



KERBL

Trainer Feeding Bag

Contenitore alimenti da addestramento. 100% in nylon.
Trainer Feeding Bag. 100% Nylon.

Art. n°	Colore Colour	Contenuto Content	
DG83608	nero-rosso black-red	500 ml	

Massage Brush

KERBL

Spazzola pulente e massaggiante, stimolante del flusso sanguigno.
Cleaning and massage brush, ideal for stimulation of the flow of blood.

Art. n°	Lunghezza Lenght	Larghezza Width	
DG81915	18 cm	12 cm	



Soft Slicker Brush

KERBL

Spazzola per la rimozione del pelo e delle piccole aree di pelo annodato.
Brush for removal of loose hair and small matted areas from the undercoat.

Art. n°	Lunghezza Lenght	Larghezza Width	
DG81904	16 cm	6 cm	
DG81905	16 cm	9 cm	



Coat Comb

KERBL

Pettine per il mantenimento e la pulizia del pelo.
Coat comb for maintaining and cleaning top hair and undercoats.

Art. n°	Lunghezza Lenght	Pettine Comb	
DG81907	21 cm	fino-grosso fine-coarse	
DG81908	21 cm	combinato combined	



Comb

KERBL

Pettine districante con dentini rotanti per un'intensa cura del pelo.
Comb for disentangling for intensive hair care.

Art. n°	Lunghezza Lenght	Larghezza Width	Pettine Comb
DG81909	15 cm	9 cm	singolo single
DG81910	15 cm	9 cm	doppio double



Pet hair remover

KERBL

Pettine per la rimozione del pelo morto, adatto al pelo di tutte le lunghezze.
Pet hair remover. Removes dead pet hair and loose undercoat. Suitable for all coat lengths.

Art. n°	Lunghezza Lenght	Larghezza Width	
DG81913	15 cm	7,5 cm	
DG81914	15 cm	10 cm	



Coat Detangling Curry Comb

KERBL

Pettine districante ideale per eliminare la lanuggine sottostante.
Coat Detangling Curry Comb for de-matting and thinning.

Art. n°	Lunghezza Lenght	Numero Lame Blade no.	
DG81916	18 cm	12	
DG81917	18 cm	20	



Nail Clippers

KERBL

Pinzette per tagliare regolarmente le unghie.
Nail clippers for all claw lengths.

Art. n°	Lunghezza Lenght		
DG81919	14 cm		

KERBL

Puppy Shampoo

art. DG82462

Shampoo per cuccioli con Aloe vera.
Puppy shampoo with Aloe vera.



The Horse World's Most Trusted Name!

Stain Remover & Whitener

art. DG00200

Una rapida azione di pulizia profonda grazie alla presenza di Oxi-Eraser® che pulisce le macchie e dona un effetto sbiancante.

- l' Oxi-Eraser® permette una pulizia ottimale anche per le macchie d'erba
 - arricchito con pantenolo, tè verde, ed estratti di frutta per un'azione nutriente del manto
 - color-safe, pH bilanciato e privo di candeggina
- A fast-acting, deep-cleansing spot remover enhanced with Oxi-Eraser® stain lifters that help to make white markings their whitest.
- Oxi-Eraser® stain lifters help remove stains and spots, including grass stains
 - Fortified with panthenol, green tea, and fruit extracts to nourish coat
 - Color-safe, pH-balanced, and bleach-free



KERBL

Mink Oil Shampoo

art. DG82461

Shampoo all'olio di visone adatto per pelo fragile e secco.

Mink Oil Shampoo helps smooth brittle and dry coat.



The Horse World's Most Trusted Name!

Detangler & Conditioner

art. DG00201

Un aiuto per mantenere il pelo liscio e privo di grovigli grazie anche alla sua azione antistatica.

- arricchito con pro-Vitamine e proteine della seta
 - profumo al gelsomino noto per la sua azione calmante
 - azione respingente contro la polvere
 - formula ad asciugatura rapida
- A grooming aid that coats each hair shaft to keep coats tanglefree, while its conditioning action reduces static fly-aways.
- Fortified with nourishing pro-vitamins and silk proteins
 - Enhanced with the calming, soothing fragrances of jasmine
 - and sandalwood
 - Helps repel dust and dirt to keep dogs clean between baths
 - Fast-drying formula



KERBL

Untangler Shampoo

art. DG82463

Shampoo antinodi alla camomilla.
Untangler Shampoo with chamomile.



The Horse World's Most Trusted Name!

Bath in a Bottle

art. DG00202

Shampoo a secco pronto all'uso

- arricchito con vitamina E per un manto sano e lucente
- pulisce, nutre, profuma e districa
- azione anti-macchie

- A ready-to-use, waterless shampoo—no rinsing required.
- Enhanced with vitamin E for shiny, healthy coats
 - Cleans, conditions, deodorizes, and detangles
 - Also helps remove spots and stains



Umbria
equitazione srl
Official



Twin Feeder

KERBL

Trogo doppio con ciotole in acciaio incluse. Regolabile in altezza.
Twin Feeder with two stainless steel bowls. Height adjustable plastic feet

Art. n°	Contenuto Content	Altezza max. Ov. Height	
DG82265	2 x 1800 ml	43 cm	
DG82258	2 x 2800 ml	43 cm	



352

www.kerbl.it



SS Bowl

KERBL

Ciotola in acciaio inox con base in gomma antiscivolo.
Stainless Steel Bowls with anti-slip.

Art. n°	Contenuto Content		
DG83417	450 ml		
DG83418	700 ml		
DG83419	900 ml		
DG83420	1800 ml		
DG83421	2800 ml		



Dumbbell XL

KERBL

Osso in robusta iuta intrecciata. Resistente e delicato sui denti.
Dumbbell in jute and cotton robust and durable, tooth-friendly.

Art. n°	Lunghezza Length	Materiale Material
DG81454	40 cm	50% juta e 50% cotone 50 % jute & 50 % cotton



Ball with Rope XL

KERBL

Palla con corda in iuta robusta e resistente, delicata sui denti.
Ball with rope in jute and cotton robust and durable, tooth-friendly.

Art. n°	Lunghezza Length	Materiale Material
DG81455	31 cm	50% juta e 50% cotone 50 % jute & 50 % cotton



Pull Toy XL

KERBL

Giocattolo in robusta iuta intrecciata. Resistente e delicato sui denti.
Pull Toy in jute and cotton robust and durable, tooth-friendly.

Art. n°	Lunghezza Length	Materiale Material
DG81456	80 cm	50% juta e 50% cotone 50 % jute & 50 % cotton



KERBL

Tooth Bone

Nodo per denti in cotone. Aiuta la pulizia dentale.
Tooth Bone in cotton . Helps dental clean.

Art. n°	Lunghezza Length	Peso Weight	
DG83468	20 cm	60 gr	
DG83469	26 cm	120 gr	
DG83470	37 cm	240 gr	
DG83471	48 cm	440 gr	

Frisbee in cotone con suono.
Frisbee made in cotton with squeaker.

Art. n°	Ø	Materiale Material
DG82328	22 cm	cotone cotton



Frisbee in nylon.
Frisbee made in nylon.

Art. n°	Ø	Materiale Material
DG83474	24 cm	nylon



Anello in gomma. Colori: rosso, giallo, blu royal.
Rubber ring. Colours: red, yellow, royal blue.

Art. n°	Colori Colours	Ø
DG9000	colori assortiti assorted colours	5 cm
DG9001	colori assortiti assorted colours	6,5 cm
DG9002	colori assortiti assorted colours	7,5 cm
DG9008	colori assortiti assorted colours	19 cm



Palla in gomma. Colori: rosso, giallo, blu royal.
Solid Rubber Ball. Colours: red, yellow, royal blue.

Art. n°	Colori Colours	Ø
DG9024	colori assortiti assorted colours	5 cm
DG9025	colori assortiti assorted colours	6,5 cm
DG9026	colori assortiti assorted colours	7,5 cm
DG9027	colori assortiti assorted colours	8,5 cm
DG9028	colori assortiti assorted colours	9 cm
DG9028A	colori assortiti assorted colours	10 cm

Palla in gomma con corda. Colori: rosso, giallo, blu royal.
Rubber Ball With Rope. Colours: red, yellow, royal blue.

Art. n°	Ø	Materiale Material
DG9036	8,5 cm	nylon e gomma nylon & rubber



Giocattolo per tiro in gomma. Colori: rosso, giallo, blu royal.
Rubber Tug Toy. Colours: red, yellow, royal blue.

Art. n°	Lunghezza Length	Materiale Material
DG9019	33 cm	gomma rubber

Spazzola in gomma morbida con manico.
Softly rubber brush with handle.

Art. n°	Materiale Material	Lunghezza Length	Larghezza Width
DG00008	gomma rubber	16 cm	5 cm



Spazzola in gomma morbida per muso.
Face Softly rubber brush.

Art. n°	Materiale Material	Lunghezza Length	Larghezza Width
DG00009	gomma rubber	12,5 cm	7 cm



CONSULTA E SCARICA IL CATALOGO COMPLETO
BÖCKMANN DAL NOSTRO SITO
WWW.UMBRIAEQUITAZIONE.COM



**VANTAGGI EVIDENTI:
CARATTERISTICO DESIGN,
MASSIMA FUNZIONALITÀ.**

Grazie al suo particolare design, la nuova famiglia Duo non passa certo inosservata. Le linee aerodinamiche rendono questi moduli ancora più leggeri al traino, con notevole riduzione del consumo di carburante. Pur non essendo visibili al primo sguardo, le numerose altre soluzioni sono semplicemente innovative, sviluppate per adattarsi alle esigenze pratiche. Tra queste figura il sistema di sicurezza Multi Safe System (MSS) delle barre di contenimento, la generosa configurazione e le ampie finestre a cerniera che garantiscono l'aerazione ideale. La nostra attenzione è sempre incentrata su una cosa: il benessere dei vostri cavalli.



Duo Esprit Duo C Duo R



Famiglia Duo.



www.umbriaequitazione.com
355

Trailer trasporto Cavalli - Horse Trailers

Famiglia Duo



Duo Esprit

Il modello base della famiglia Duo garantisce un'esperienza di guida divertente con le sue sospensioni CFFplus'. Con il pavimento in gomma e la superficie di gomma con barre passanti sul portellone posteriore, il carico e lo scarico, sul Duo Esprit, diventa facile sia per il cavallo che per il cavaliere. L'ottimo rapporto qualità prezzo del modello Esprit è un netto vantaggio!

Informazioni in breve

Numero di cavalli	
Carrozzeria (Tetto in multistrato)	Serie:
Tetto (Poliestere)	Serie:
Telaio (serie)	CFF PLUS
Telaio (optional)	WCF PLUS

In evidenza



Tenuta di strada ottimale grazie al telaio ribassato con sospensioni Comfort con ammortizzatore shock absorber



Dotazione di serie completa	Pagina	358
Accessori	Pagina	359



Duo C

Con la sua solida struttura, la carrozzeria in multistrato a 13 lamine ed un ricco equipaggiamento, il Duo C non ha bisogno di grandi presentazioni. Tra gli optional vi sono una selleria con portaselle estraibili e regolabili in altezza, illuminazione interna ed un vasto pacchetto di accessori.

Informazioni in breve

Numero di cavalli	
Carrozzeria (Tetto in multistrato)	Serie:
Tetto (Poliestere)	Accessori:
Telaio (serie)	CFF^{PLUS}
Dotazione di serie	Multi Safe System** MSS
Telaio (optional)	WCF^{PLUS}

In evidenza tra la dotazione in serie



Il nuovo sistema di sicurezza di barre di contenimento regolabili in altezza e lunghezza (sistema antipanico) Multi Safe System** davanti e dietro



i Dotazione di serie completa	Pagina	358
Accessori	Pagina	359



Duo R

La forma aerodinamica del Duo R offre un ampio spazio in altezza per il vostro cavallo ed altro spazio aggiuntivo nella selleria di serie, oltre all'esclusiva estetica della parte frontale in poliestere Böckmann. Dotato inoltre di portaselle estraibili e regolabili in altezza.

Informazioni in breve

Numero di cavalli	
Carrozzeria (Tetto in multistrato)	Serie:
Tetto (Poliestere)	Accessori:
Telaio (serie)	CFF^{PLUS}
Dotazione di serie	Multi Safe System** MSS
Telaio (optional)	WCF^{PLUS}

In evidenza tra la dotazione in serie



Selleria con portaoggetti, portaselle estraibili, paletta, scopa, specchio, retina, portaguadrappo ed illuminazione interna



i Dotazione di serie completa	Pagina	358
Accessori	Pagina	359

Famiglia Comfort.



UNO STILE UNICO CHE SODDISFA LE PIÙ ALTE ESIGENZE.

La famiglia Comfort dotata di carrozzeria in poliestere super-rinforzato sono rimorchi molto robusti concepiti per durare nel tempo. Equipaggiati per l'uso quotidiano. Gli accessori di serie come il sistema di sicurezza Multi Safe System (MSS) delle barre di contenimento, il pavimento in alluminio di alta qualità o la parte frontale della selleria in poliestere soddisfano le più alte esigenze dei cavalli e dei cavalieri. L'efficienza di tutti questi elementi non appesantisce lo stile: il design unico è assolutamente d'effetto e lascia il segno ovunque.



Comfort



Comfort

 Capirete subito perché questo rimorchio per cavalli si chiama "Comfort". La forma sportiva e dinamica e il comfort delle sospensioni shock absorber "CFFplus" garantiscono una piacevole esperienza di guida. Ma soprattutto, l'ampio spazio per la testa del cavallo e le numerose possibilità di sistemazione della selleria fanno di Comfort un prodotto che non ha bisogno di presentazione. Il set di accessori è completato dal Multi Safe System (MSS).

Informazioni in breve

Numero di cavalli



Carrozzeria (Poliestere al 100%)



Telaio (serie)



Dotazione di serie



Telaio (optional)



In evidenza tra la dotazione in serie



Selleria con portaoggetti, portaselle estraibili, paletta, scopa, specchio, retina sulla porta, portagualdrappe ed illuminazione interna



Dotazione di serie completa	Pagina	358
Accessori	Pagina	359



	Duo Esprit	2000 Kg*	2730 mm	2200 mm	4500 mm	2300 mm	1650 mm	3100 mm	1161 Kg*	
	Duo C	2400 Kg*	2730 mm	2200 mm	4500 mm	2300 mm	1650 mm	3100 mm	1539 Kg*	
	Duo R	2400 Kg*	2730 mm	2200 mm	4500 mm	2300 mm	1650 mm	3280 mm	1509 Kg*	
	Comfort	2400 Kg*	2730 mm	2200 mm	4500 mm	2300 mm	1650 mm	3240 mm	1501 Kg*	

Si riserva di apportare modifiche agli elementi di design e attrezzatura. Pesì e dimensioni indicativi che possono variare a seconda delle dotazioni aggiuntive.

*Possibile riduzione del peso totale

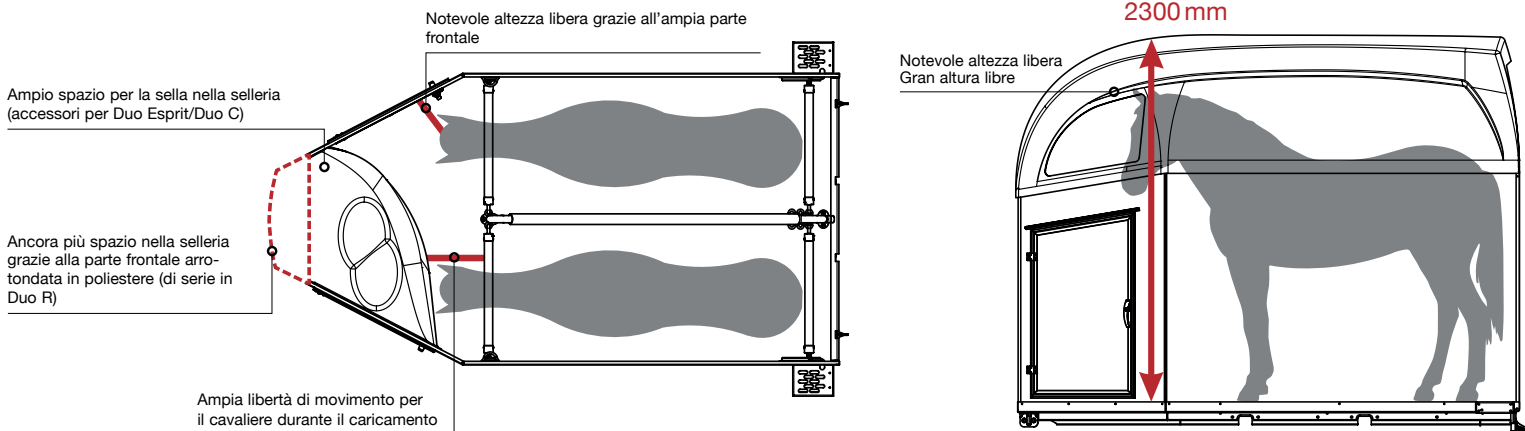

Telaio



Tenuta di strada ottimale grazie al telaio ribassato con sospensioni Comfort con ammortizzatore shock absorber

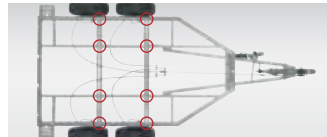

Progettato per sopportare carichi elevati grazie alla struttura longitudinale con assi rinforzati in 8 punti e intelaiatura in acciaio zincata a caldo



Sicurezza nell'aggancio e sgancio grazie al giunto in ghisa con serratura, comoda maniglia rivestita e soft top (dispositivo antiavviamento) (escluso Duo Esprit)

Altri accessori di serie:

- Timone a V fissato con ruotino portante automatico
- Grande unità di illuminazione con proiettore di retromarcia e presa a 13 poli
- Pneumatici sovradimensionati di alta qualità
- Giunto in ghisa con serratura, comoda maniglia rivestita e Soft-Top (dispositivo antiavviamento)

Carrozzeria



Design accattivante e ricircolo di aria fresca grazie al tetto in poliesteri argento metallizzato, dotato di ampie finestre a compasso antiriflesso per un'aerazione ottimale



Clima interno ottimale grazie alla tenda canvas con rete integrata** (protezione antipio-gia e antifreddo) (escluso Duo Esprit)



Rampa posteriore altamente resistente con rinforzo a 4 braccia in acciaio e 2 stecche solide per lato con fori speciali (chiuse dietro). Duo Esprit 3 braccia in acciaio

Altri accessori di serie:

- Carrozzeria in multistrato con rivestimento in plastica
- 304 viti in acciaio inox sulla carrozzeria
- Parafanghi in plastica antiurto
- Dispositivo di sollevamento della rampa posteriore
- Carrozzeria totalmente in poliesteri (Comfort)
- Maniglia ergonomica
- Decorazioni con testa di cavallo sulla parete laterale
- Porte con serratura con sistema di chiusura a 3 punti

Equipaggiamento interno

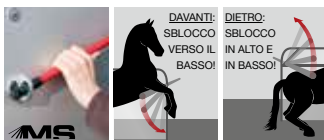

Il nuovo sistema di sicurezza di barre di contenimento regolabili in altezza e lunghezza (sistema antipánico) Multi Safe System*** davanti e dietro (escluso Duo Esprit)

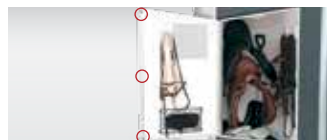

Pratica selleria (di serie nel Duo R) con sistema di chiusura a 3 punti; un passe-partout per aprire tutte le porte e il giunto in ghisa



Appoggio stabile grazie agli speciali battistrada trasversali e ai fermi laterali sul rivestimento della rampa posteriore

Altri accessori di serie:

- Divisorio trasparente in PVC, flessibile con la parte superiore in PVC
- Pavimento in gomma antiscivolo, incollato e sigillato
- Illuminazione interna con interruttore
- Selleria con portaoggetti, portaselle estraibili e regolabili in altezza, paletta, scopa telescopica, specchio, retina sulla porta, portagualdrappe ed illuminazione interna (optional nei modelli Duo Esprit, Duo C).

Telaio



Solido e inalterabile grazie al pavimento in alluminio di alta qualità



Effetto ottico d'impatto grazie ai cerchi in alluminio



Copertura per aggancio resistente agli agenti atmosferici, per un'efficace protezione contro lo sporco e l'umidità

Altri optional:

- Adattatore 13/7 poli
- Aumento del peso totale (su richiesta)

Per altri accessori rivolgetevi al vostro partner Böckmann più vicino, che sarà lieto di fornirvi una consulenza competente



Un comfort di guida superiore grazie al telaio World Class conforme allo standard automobilistico con ammortizzatori shock absorber, sospensioni sulla ruota esterna zincata e sospensioni a vite

Carrozzeria



Pratiche soluzioni per riporre gli oggetti grazie alla staffa portastelle e portagualdrappe (di lato sul rimorchio)



Mai più in panne grazie alla ruota di scorta, supporto e copri ruota di scorta



Comodo agganciamento grazie al pratico specchietto d'accostamento che assicura una buona visualizzazione del gancio di traino assistendovi alla guida con la vostra auto

Altri optional:

- Seconda porta di accesso aggiuntiva a sinistra – nei modelli in legno e alluminio (solo nei modelli senza selleria)
- Specchietto d'accostamento
- Terza luce di arresto
- Supporto posteriore per sulky

Per altri accessori rivolgetevi al vostro partner Böckmann più vicino, che sarà lieto di fornirvi una consulenza competente



Sicurezza sulla strada grazie alle griglie ribaltabili per puledri



Rampa posteriore/1 combinata con porta a doppio battente (solo nei modelli Duo e Comfort)



Effetto ottico d'impatto grazie alle braccia laterali rivestite in poliestere e ai parafranghi in poliestere su ruota singola



Pedellino brevettato che può essere aperto con facilità sulla rampa posteriore



Clima interno ottimale grazie alle finestre laterali scorrevoli sul tetto in poliestere, alle porte in alluminio o alle pareti laterali



Chiusura posteriore in poliestere dotata di serratura con molla a gas (solo per modello Comfort)

Equipaggiamento interno



Durata nel tempo grazie al rivestimento paraferri (in plastica) sulle pareti laterali



Tappetino antilogoramento per le zampe anteriori, per una maggiore durata nel tempo



Comoda posizione da fermo grazie all'imbottitura dei lati

Altri optional:

- Punto luce interno aggiuntivo sul tetto in poliestere
- Barre di contenimento rivestite per tutto il perimetro (parete laterale – paratia, parete laterale – lato)
- Selleria interna in poliestere per rimorchi a 1 cavallo con porta interna
- Selleria interna in poliestere con 2 mangiatoie per rimorchi a 2 cavalli (per il modello Duo C), con portastelle estraibili, paletta, scopa, specchio, retina sulla porta, portagualdrappe e illuminazione interna come equipaggiamento di serie

Per altri accessori rivolgetevi al vostro partner Böckmann più vicino, che sarà lieto di fornirvi una consulenza competente



Trasporto sicuro garantito dalla griglia separatesta in alluminio, ad esempio per trasportare due stalloni



Contatto visivo garantito con la griglia separatesta



Trasporto monitorato grazie al sistema di video sorveglianza



A

abbigliamento da concorso	19-27
accessori da box	305-330
articoli da regalo	333-341
articoli per cani	346-358
attacchi e accessori	121-126

B

bauli portasella	320-321
biothane	128
bisacce	68-69
bomber e giacchetti	33-34
borse	65-67
borse portasella	63
briglie	85-93
bustini protettivi	36-37

C

calzini	38
cartelli segnaletici	330
caschi	39-41
cavezze	129-135
cavezzoni da doma	108
chambon	105
chiodi	273-275
chiudibocca	94
cinture	27
collari per tic	329
compensatori per sella	188-189
coperte	191-201
copriseggio e coprisella	64

D

doma	108-120
doma argentina	115
doma maremmana	113-114
doma spagnola	108, 116-120

G

ghette	9-11
giacche e camicie	19-24
ginocchiere	38
gogue	105
groom	288-304
guaine	329
guanti	28-32
gusci	83

H

horse ball	332
------------	-----

I

impermeabili	35
--------------	----

F

fasce e sottofasce	226-228
fasce per la schiena	38
fascioni da doma	111-112
fascioni da volteggio	112
ferri	270-271
fibbiera e moschettoni	342-344
frontalini	95-96
fruste e frustini	206-216

L

lettere da dressage	330
longe	138
lunghine	135-138

M

martingale	100-104
mascalcia	263-269, 286
maschere antimosche	204
morsi e accessori	140-159

P

pantaloni	12-18
paracolpi da trasporto	229-230
pettorali	100-104
plastron	25
porta-numeri da gara	38
portasella e provasella	322-324
portastivali	65-66
prodotti	232-246
protezioni per il cavallo	218-225

R

ramponi	272
recinzioni elettriche	249-261
redini	97-99
redini di ritorno	109

S

sali minerali	247
scarpette per cavallo	283-286
selle	43-61
sottocoda	106
sottopancia	78-82
sottosella	165-189
speroni e accessori	161-163
spille per plastron	26
staffe e pedane	72-77
staffili	70-72
stampe soggetti equestri	340-341
stivaletti	2-4
stivali	5-8

T

tosatrici e accessori	276-282
trailers trasporto cavalli	355-359

A

argentinian horse equipment 316

B

back protections 188-189
 back protector (for man) 38
 bandages and bandages pads 226-228
 belts 27
 biothane 128
 bits and accessories 140-159
 body numbers 38
 body protectors 36-37
 bombers and jackets 33-34
 boots (long) 5-8
 boots (short) 2-4
 boots carrying bags 65-66
 box equipments 305-330
 breastplate 100-104
 breeches 12-18
 bridles 85-93
 brooches and plastrons 26
 browbands 95-96
 buckles and snap hooks 342-344

C

care products 232-246
 carriage and accessories 121-126
 carrying bags 65-67
 cavessons 108
 chambon 105
 clippers and accessories 276-282
 competition jackets and shirts 19-24
 crampons 272
 crupper 106

D

draw reins 109
 dressage markers 330

E

electric fences and accessories 249-261

F

farrier tools 263-269, 286
 fly masks 204

G

gifts 333-341
 girths 78-82
 girth covers 83
 gloves 28-32
 gogues 105
 grooming 288-304

H

halters 129-135
 helmets 39-41
 hinge cribbing 329
 horseball 332
 horse boots 283-286
 horseshoe 270-271

K

knee protections 38

L

lunging reins 138
 leads 135-138

M

maremmana horse equipment	113-114
martingale	100-104
mini chaps	9-11

N

nails	273-275
neck sweat	329
nosebands	94

P

pet equipment	346-353
plastrons	25
prints (horse subjects)	340-341
protections	218-225

R

raincoats	35
reins	97-99
riding wear	19-27
rollers	111-112
rugs	191-201

S

saddles	43-61
saddle bags	68-69
saddle carrying bags	63
saddle covers	64
saddle pads	165-188
saddle racks and saddle stands	322-324
saddle trunk	320-321
salt blocks	247
seat cover	64
shipping boots	229-230
signboards	330
socks	38
spanish horse equipment	108, 116-120
spurs	161-163
stirrups and pads	72-77
stirrups straps	70-72

T

trailers	355-359
training aid	108-120

V

vaulting roller	112
-----------------	-----

W

whips	206-216
-------	---------